



RED HEAD[®]

CONCRETE ANCHORING SYSTEMS



Notes

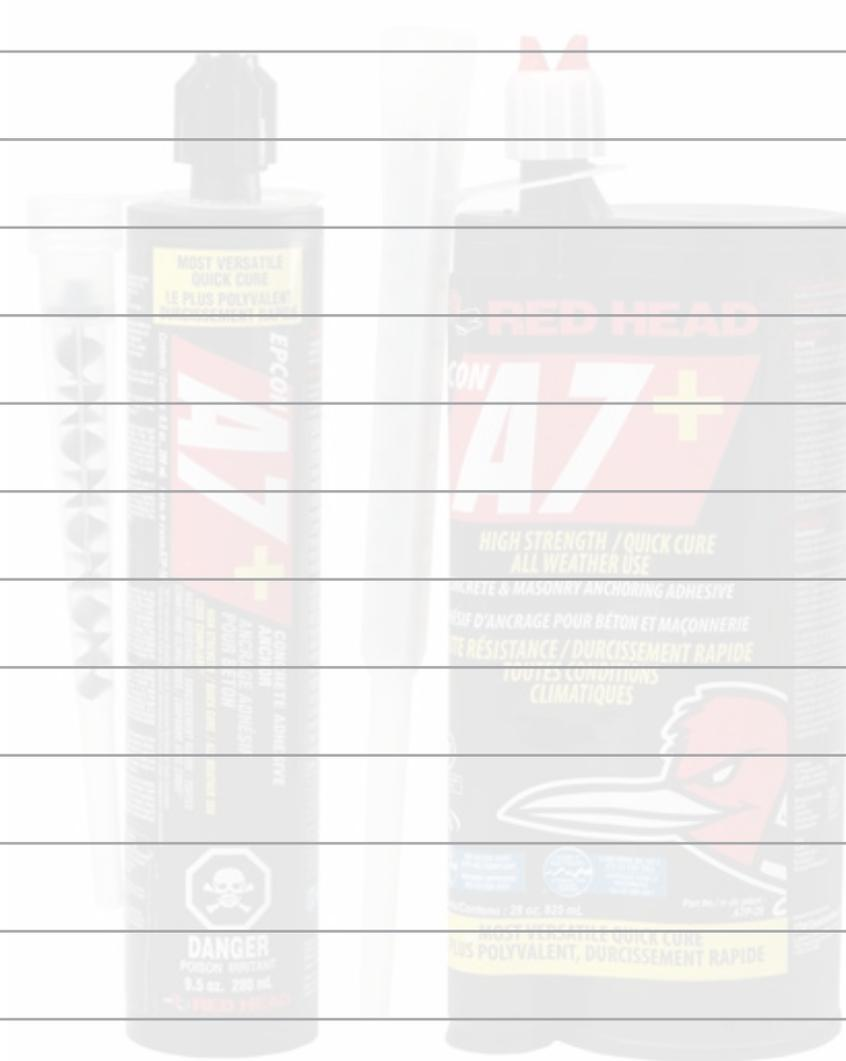

TABLE OF CONTENTS



Anchoring Working Principles	RH 4
Red Head Adhesive Anchoring Systems	RH 7
Adhesive Anchoring Selection Guide	RH 8
A7+ Adhesive	RH 10
Umbrella Inserts and Stubby Screens	RH 21
Screen Tubes	RH 24
Accessories	RH 26
Mechanical Anchoring	RH 27
Mechanical Anchoring Selection Guide	RH 28
Trubolt Wedge Anchors	RH 32
Large Diameter Tapcon (LDT) Anchors	RH 34
Tapcon+ Drop-In Anchors	RH 39
Multi-Set II Drop-in Anchors	RH 44
Dynabolt Sleeve Anchors	RH 48
Hammer-Set Anchors	RH 51
Truspec Anchor Design Software	RH 52



The Inside Story About Mechanical and Adhesive Anchors

Types, Base Materials,
Installation Procedures
and More

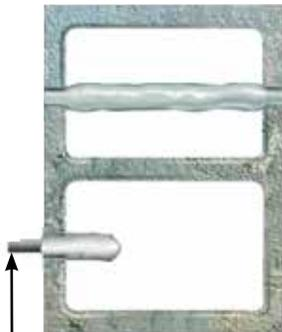

Top View

For attachments to single face of block, see page RH 29 for information on "umbrella anchors" and "stubby screens"

HOLLOW CONCRETE BLOCK

Maximum holding strength in concrete block can be obtained by fastening to both the front and back of the block using an adhesive screen tube and threaded rod.



Expansion Type—

Tension loads are transferred to the base material through a portion of the anchor that is expanded inside the drill hole.

Examples: Red Head Trubolts, Dynabolts, Multi-Set II Anchors and Hammer-Sets



Adhesive Type—

Resistance to tension loads is provided by the presence of an adhesive between the threaded rod (or rebar) and the inside walls of the drill hole.

Examples: A7+ Adhesive

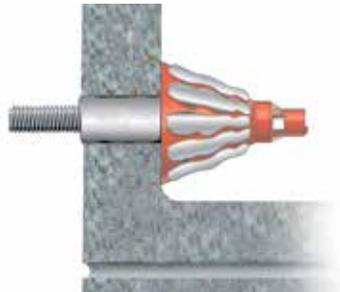

Keying Type—

Holding strength comes from a portion of an anchor that is expanded into a hollow space in a base material that contains voids such as concrete block or brick.

Examples: Adhesives used in screen tubes or umbrella insert



Mechanical Interlocking Type—

Tension loads are resisted by threads on the fastener engaging with threads cut into the base material.

Examples: LDT, Tapcon and E-Z Ancors

BASE MATERIALS

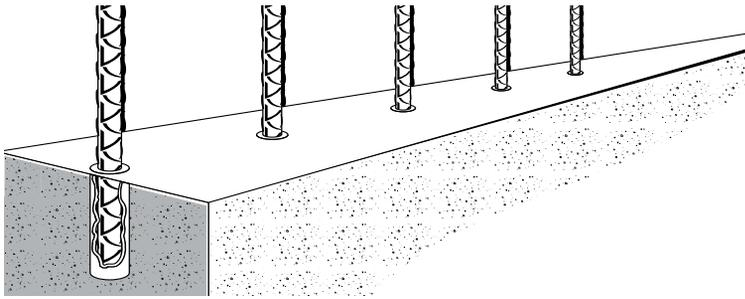

Concrete

Normal Weight Concrete is made from Portland cement, coarse and fine aggregates, water and various admixtures. The proportioning of these components controls the strength of the concrete. In North America, concrete strength is specified by the compressive strength* of concrete test cylinders. These test cylinders measure six inches in diameter by 12 inches in length and are tested on the 28th day after they are produced.

Lightweight Concrete consists of the same components (cement, coarse and fine aggregates, water and admixtures) as normal weight concrete, except it is made with lightweight aggregate. One of the most common uses of lightweight concrete has been as a structural fill of steel decking in the construction of strong, yet light floor systems.

Typical fasteners for both normal weight and lightweight concrete include Trubolt Wedge Anchors, LDT Self-Threading Anchors, Dynabolt Sleeve Anchors, Multi-Set II Drop-In Anchors, Stud Anchors and Adhesive Anchoring Systems.

* Compressive strengths shown in this catalog were the actual strengths at the time of testing. The load values listed were determined by testing in un-reinforced concrete.

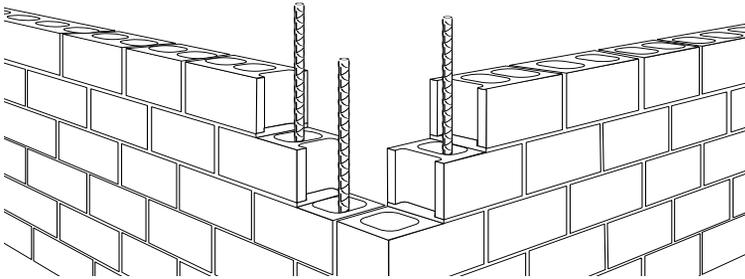

Masonry

Grout-Filled Concrete Block consists of three components: concrete, mortar and grout. The mortar is designed to join the units into an integral structure with predictable performance properties. Typical fasteners for grout-filled block include Dynabolt Sleeve Anchors, and A7+ Adhesive Anchoring Systems.

Hollow Concrete Block, Brick and Clay Tile are grouped together because they require special anchoring products that can be installed into a substrate that contains voids and still provide reliable holding values. Typical fasteners used in hollow block, brick and clay tile include Dynabolt Sleeve Anchors, Tapcon Self-Tapping Concrete Anchors, Adhesives with Screen Tubes and Adhesives used with the Umbrella Insert.

INSTALLATION PROCEDURES

Anchor drill holes are typically produced using carbide tipped drill bits and rotary hammer drills. Look at the product sections of this catalog for the correct drill hole diameter and depth of each type of anchoring system.

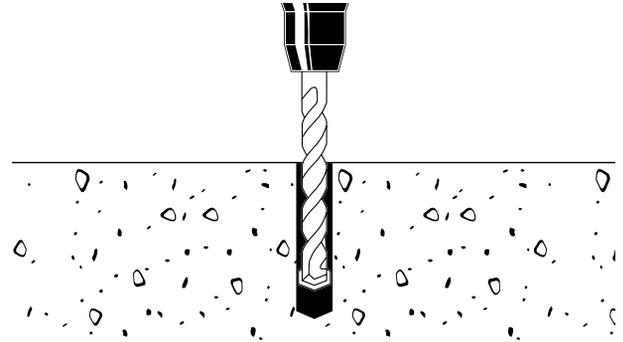

Careful cleaning of the anchor drill hole is important in order to obtain the best possible functioning of the anchor system. For each product in this catalog, detailed installation instructions are provided. Suggested clamping torques and curing times (for adhesive anchors) are also provided.

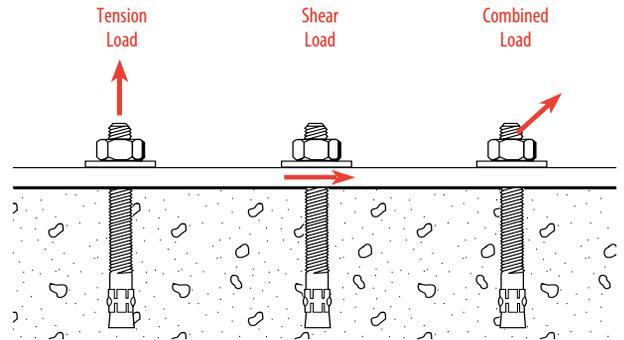

Loading

Holding values for the following types of loading are provided in this catalog:

- **Tension loads—**
when load is applied along the axis of the anchor
- **Shear loads—**
when the loads are applied perpendicular to the axis of the anchor
- **Combined loads—**
when both tension and shear loads are applied to an anchor, a combined loading equation is provided to determine the maximum loads that can be applied to the anchor at the same time

MODES OF FAILURE

When anchors are loaded to their maximum capacity, several different types (modes) of failure are possible depending on the type of anchor, strength of the base material, embedment depth, location of the anchor, etc. Common modes of failure include:

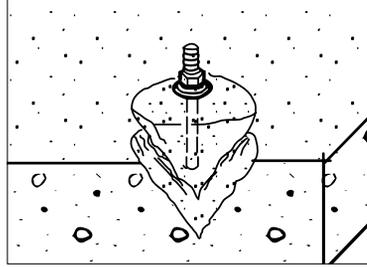

Concrete Spall Cone—

Usually occurs at shallow embedments where the resistance of the base material is less than the resistance of the anchor and the base material fails.

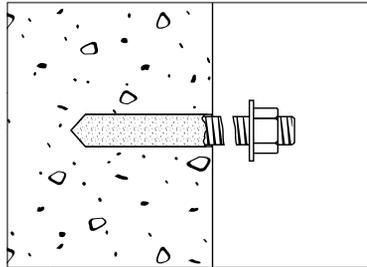

Steel Breakage—

The capacity of the anchorage exceeds the tensile or shear strength of the steel anchor or rod material.

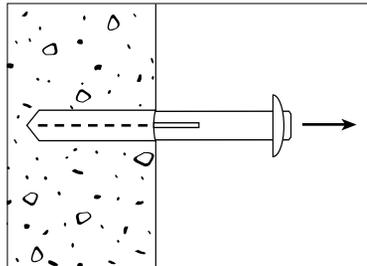

Anchor Pullout—

Base material adjacent to the extension portion of an anchor crushes, resulting in the anchor pulling out of the hole until the capacity of the spall cone is reached, at which point the concrete will spall. This type of failure happens more commonly when anchors are set with deep embedment depths.

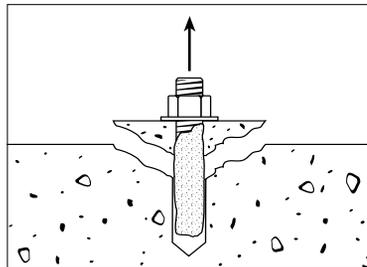

Bond Failure—

Shear failure of the adhesive at rod-adhesive interface or adhesive-base material interface. Occurs more commonly in deep embedments using high strength steel rods.

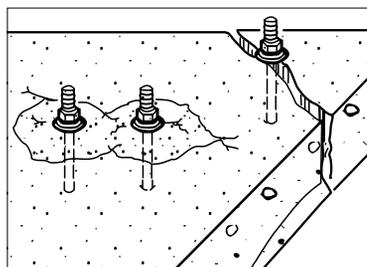

Edge Distance and Spacing Reduction—

Reduces the holding values, when anchors are placed too close to the edge. This also occurs when two or more anchors are spaced closely together. See suggested edge distance, anchor spacing distances and reduction values in the product sections.

Because applications vary, ITW RED HEAD cannot guarantee the performance of this product. Each customer assumes all responsibility and risk for the use of this product. The safe handling and the suitability of this product for use is the sole responsibility of the customer. Specific job site conditions should be considered when selecting the proper product. Should you have any questions, please call the Technical Assistance Department at 800-899-7890.



*Engineered to provide
consistently strong
holding power for superior
anchoring in solid concrete
and hollow masonry*

The RED HEAD Adhesive Anchoring System includes a complete family of quality products and accessories designed to work in a variety of fastening applications. Get maximum anchoring performance with:

Epoxy Systems—Epoxyes are very strong (1-1/2 times stronger than mechanical anchors) and insensitive to moisture. Mix ratio and thorough blending of the hardener and resin are important with epoxyes. Maximum performance of RED HEAD epoxyes is achieved by accurate proportions and mixing provided by our highly engineered cartridges, mixing nozzles, and dispensing tools.

Hybrid Systems—Combine an excellent mixing ability and chain reaction curing mechanism with a tough, hybrid adhesive. Our hybrid chemistry is ideal for anchoring because it dispenses fast, is not mix ratio sensitive, provides ample working time, and cures extremely fast in small and large diameter holes. Rods are easier and faster to insert in acrylic adhesives than epoxy adhesives at all temperatures.



Adhesive Anchoring Selection Guide

COLD WEATHER USE
and lower -10°C -7°C 10°C
A7+ – BEST FORMULA

HOT WEATHER USE
27°C 32°C 38°C and higher
A7+



Doweling into Concrete with Rebar



Fastening to Concrete with Threaded Rod

Solid Concrete Applications

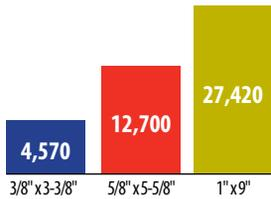

PRODUCT SYSTEMS	KEY FEATURES	PROPERTIES	40 MPa UNCRACKED FACTORED RESISTANCE IN TENSION (Ibf)																					
<p>A7+ <i>Fast Dispensing, Fast Curing Adhesive for All Conditions</i> Most versatile quick cure solution</p>  <p>9.5 fluid oz. (280 ml) and 28 fluid oz. (825 ml) cartridges (see page RH 10)</p>	<ul style="list-style-type: none"> All weather formula for for both hollow and solid base material Great performance in damp holes and underwater applications Applicable for both structural and non-structural anchoring Fast curing time, 45 minutes at 21°C No drip, no sag, easy clean up, low odor Rods are easier to insert into the hole with A7+ compared with other adhesives Hole only needs to be 1/16" larger than the stud (competition requires 1/8" larger) Approved for cracked, uncracked, seismic, masonry NFS 61 approved 	<table border="1"> <thead> <tr> <th>BASE MATERIAL (F°/C°)</th> <th>WORKING TIME</th> <th>FULL CURE TIME</th> </tr> </thead> <tbody> <tr> <td>110°/ 43°</td> <td>1.5 minutes</td> <td>45 minutes</td> </tr> <tr> <td>90°/ 32°</td> <td>2.5 minutes</td> <td>45 minutes</td> </tr> <tr> <td>70°/ 21°</td> <td>5 minutes</td> <td>45 minutes</td> </tr> <tr> <td>50°/ 10°</td> <td>16 minutes</td> <td>90 minutes</td> </tr> <tr> <td>32°/ 0°</td> <td>35 minutes</td> <td>4 hours</td> </tr> <tr> <td>14°/ -10°</td> <td>35 minutes</td> <td>24 hours</td> </tr> </tbody> </table> <p>Adhesive must be a minimum temperature of 32°F (0°C) for proper installation</p>	BASE MATERIAL (F°/C°)	WORKING TIME	FULL CURE TIME	110°/ 43°	1.5 minutes	45 minutes	90°/ 32°	2.5 minutes	45 minutes	70°/ 21°	5 minutes	45 minutes	50°/ 10°	16 minutes	90 minutes	32°/ 0°	35 minutes	4 hours	14°/ -10°	35 minutes	24 hours	
BASE MATERIAL (F°/C°)	WORKING TIME	FULL CURE TIME																						
110°/ 43°	1.5 minutes	45 minutes																						
90°/ 32°	2.5 minutes	45 minutes																						
70°/ 21°	5 minutes	45 minutes																						
50°/ 10°	16 minutes	90 minutes																						
32°/ 0°	35 minutes	4 hours																						
14°/ -10°	35 minutes	24 hours																						



Hollow Base Material Applications

Use the following accessories with the A7+ adhesive anchoring systems for all of your hollow base material applications.

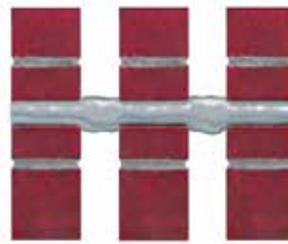

Brick Pinning

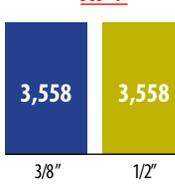

Fastening to hollow concrete block

SYSTEM ACCESSORIES	KEY FEATURES	ULTIMATE TENSILE ^{1,2} PERFORMANCE (LBS)				
<h3>Nylon Screens</h3>  <p>Makes it possible to use adhesive for fastening to hollow block or brick walls (see page RH 32)</p>	<ul style="list-style-type: none"> 3/8" to 3/4" diameter sizes 30%-50% lower cost than stainless screens Special design makes screens easier to insert through block or brick Does not get bent or crushed Corrosion resistant 	<p>A7+</p>  <table border="1"> <tr> <td>2,360</td> <td>2,647</td> </tr> <tr> <td>3/8" x 8"</td> <td>3/4" x 8"</td> </tr> </table>	2,360	2,647	3/8" x 8"	3/4" x 8"
2,360	2,647					
3/8" x 8"	3/4" x 8"					
<h3>Stubby Screens</h3>  <p>Makes it possible to use adhesive for fastening to the face of hollow block or tile (see page RH 29)</p>	<ul style="list-style-type: none"> 3/8", 1/2", 5/8" diameter sizes Fasten to front face of block Anchor remains perpendicular in wall 	<p>A7+</p>  <table border="1"> <tr> <td>2,458</td> <td>2,543</td> </tr> <tr> <td>1/2"</td> <td>5/8"</td> </tr> </table>	2,458	2,543	1/2"	5/8"
2,458	2,543					
1/2"	5/8"					
<h3>Umbrella and Umbrella Inserts</h3>  <p>Makes it possible to use adhesive for fastening to the face of hollow block or tile (see page RH 29)</p>	<ul style="list-style-type: none"> For 3/8" rods 3/8" internal inserts Fasten to front face of blocks Creates large bearing surface inside block to achieve high loads 	<p>A7+</p>  <table border="1"> <tr> <td>3,558</td> <td>3,558</td> </tr> <tr> <td>3/8"</td> <td>1/2"</td> </tr> </table>	3,558	3,558	3/8"	1/2"
3,558	3,558					
3/8"	1/2"					

¹ Testing performed in hollow concrete block.

² Diameter x Embedment.

A7+

Most versatile quick cure adhesive solution for light, medium, and heavy duty concrete anchoring that meets code approval



A7P-10

A7P-28



A100

DESCRIPTION/SUGGESTED SPECIFICATIONS*

*Suggested Specifications see pages RH 13

Fast Dispensing, Fast Curing Hybrid Adhesive

This hybrid adhesive is dispensed from a dual cartridge through a static mixing nozzle, directly into the anchor hole. A7+ is a quick cure adhesive specifically designed for both structural and non-structural anchoring applications. It comes in both 9.5 fluid oz. and 28 oz.

ADVANTAGES

- All weather formula for for both hollow and solid base material
- Great performance in damp holes and underwater applications
- Applicable for both structural and non-structural anchoring
- Fast curing time, 45 minutes at 21°C
- No drip, no sag, easy clean up, low odor
- Rods are easier to insert into the hole with A7+ compared with other adhesives
- Hole only needs to be 1/16" larger than the stud (competition requires 1/8" larger)
- Approved for cracked, uncracked, seismic, masonry
- NFS 61 approved

Spacing and Edge Distance

NOMINAL ANCHOR DIAMETER (IN.)	MINIMUM SPACING (IN.)	MINIMUM EDGE DISTANCE (IN.)
3/8	1	1
1/2	1-1/2	1-1/2
5/8	2-1/2	2-1/2
3/4	3	3
7/8	3-1/2	3-1/2
1	4	4
1-1/4	5	5

Curing Times

BASE MATERIAL (F°/C°)	WORKING TIME	FULL CURE TIME
110°/ 43°	1.5 minutes	45 minutes
90°/ 32°	2.5 minutes	45 minutes
70°/ 21°	5 minutes	45 minutes
50°/ 10°	16 minutes	90 minutes
32°/ 0°	35 minutes	4 hours
14°/ -10°	35 minutes	24 hours

*Adhesive must be a minimum temperature of 32°F (0°C) for proper installation

APPLICATIONS



Stadium Seating

The fast dispensing, fast curing properties of A7+ made it ideal for installing over 70,000 seats in this NFL football stadium and many others.



Roadway Doweling

A7+ dispenses so quickly and rebar inserts so easily that contractors find installed costs are lower than many other products including grout for doweling.



Water Treatment Facilities

The fast dispensing, fast curing properties of A7+ make it ideal for repetitive installation processes.

FEATURES



ANCHORAGE TO SOLID CONCRETE

Threaded Rod (Carbon or Stainless Steel) or Rebar supplied by contractor; rod does not need to be chisel pointed

A7+ adhesive completely fills area between rod and hole creating a stress free, high load anchorage

Pre-drilled hole in concrete; see performance tables for suggested hole sizes

APPROVALS/LISTINGS

ASTM C881 Type I, II, IV & V; Grade 3, Class A, B, & C with the exception of gel time (Class C only)

ICC ESR-3903 for concrete and ICC IAPMO ER-890 for masonry

MTO Approval

MTQ Approval

BC MoTI Approval

NSF 61 Compliant



Certified to ANSI/NSF 61

INSTALLATION STEPS

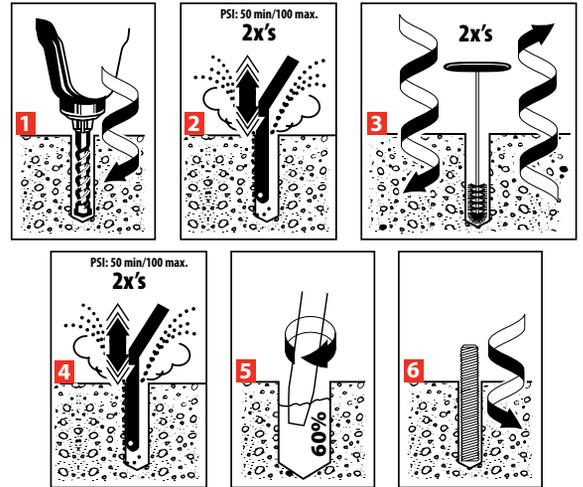

1. Use a rotary hammer drill or pneumatic air drill with a carbide drill bit complying with ANSI B212.15. Drill hole to the required embedment depth. For installation of 3/8" – 1-1/4" anchors, see www.itwredhead.com for a bit diameters and min/max embedment depths.
2. Starting at the bottom of the hole, move a clean air nozzle in and out of the hole, cleaning with compressed air. Repeat until free of debris.**
3. Select appropriately sized Red Head brush based on anchor diameter and depth of hole. See www.itwredhead.com for brush specifications, including minimum diameter. Check brush for wear before use. Insert the brush into the hole with a clockwise motion until the bottom of hole is reached. Pull brush out of hole and repeat at least one additional time. For faster cleaning, attach the brush to a drill/drive.
4. Repeat Step 2
5. Place the cartridge/nozzle assembly into the dispensing tool. Note: Do not modify or remove mixing elements in nozzle. Review the gel time/cure time chart, based on the temperature at time of installation, in order to determine tool, cartridge and nozzle requirements. Dispense mixed adhesive outside of hole until uniform color is achieved. Insert the nozzle to the bottom of the hole and dispense adhesive until hole is 2/3 full. If nozzle does not reach the bottom of the hole, use Red Head extension tubing positioned on the end of the nozzle. For holes that contain water, keep dispensing adhesive below water in order to displace the water upward.
6. Immediately insert the rod/rebar assembly to the required embedment depth using a slow rotating motion. The anchor rod/rebar must be marked with the required embedment depth. Ensure the adhesive fills all voids and uniformly covers rod/concrete. Do not disturb anchor or apply load/torque until adhesive is fully cured.

A7P-28 fl. oz. Ordering Information

PART NUMBER	DESCRIPTION	BOX QTY
 A7P-28	28 Fluid Ounce Cartridge A7+ with nozzle	4
 S55	Mixing Nozzle for A7P-28 Cartridge Nozzle diameter fits holes for 3/8" diameter & larger anchors (overall length of nozzle 10")	24
 S75	High Flow Mixing Nozzle for A7P-28 Cartridge Nozzle diameter fits holes for 5/8" diameter & larger anchors (overall length of nozzle 9-1/4")	24

PART NUMBER	DESCRIPTION	BOX QTY
 A102-V3	Largest hand dispensable cartridge— still easy to dispense Hand Dispenser for A7P-28 Cartridge	1
 A200	Pneumatic Dispenser for A7P-28	1
 A300	Cordless Battery Dispenser for A7P-28 Cartridge. Includes one battery and charger. Works with all Milwaukee® M18™ batteries	1

Refer to page RH 34 for ordering information on wire brushes, brush extensions, and blow pump for deep holes.

ESTIMATING TABLE

A7+

28 Fluid Ounce Cartridge

Number of Anchoring Installations per Cartridge* Using Reinforcing Bar with A7+ Adhesive in Solid Concrete

REBAR	DRILL HOLE DIA. INCHES	EMBEDMENT DEPTH IN INCHES (mm)														
		1 (25.4)	2 (50.8)	3 (76.2)	4 (101.6)	5 (127.0)	6 (152.4)	7 (177.8)	8 (203.2)	9 (228.6)	10 (254.0)	11 (279.4)	12 (304.8)	13 (330.2)	14 (355.6)	15 (381.0)
#3	7/16	560.3	280.2	186.8	140.1	112.1	93.4	80.0	70.0	62.3	56.0	50.9	46.7	43.1	40.0	37.4
10M	9/16	339.0	169.5	113.0	84.7	67.8	56.5	48.4	42.4	37.7	33.9	30.8	28.2	26.1	24.2	22.6
#4	5/8	274.6	137.3	91.5	68.6	54.9	45.8	39.2	34.3	30.5	27.5	25.0	22.9	21.1	19.6	18.3
#5 or 15M	3/4	190.7	95.3	63.6	47.7	38.1	31.8	27.2	23.8	21.2	19.1	17.3	15.9	14.7	13.6	12.7
#6 or 20M	7/8	140.1	70.0	46.7	35.0	28.0	23.3	20.0	17.5	15.6	14.0	12.7	11.7	10.8	10.0	9.3
#7	1	107.2	53.6	35.7	26.8	21.4	17.9	15.3	13.4	11.9	10.7	9.7	8.9	8.2	7.7	7.1
#8 or 25M	1 1/8	84.7	42.4	28.2	21.2	16.9	14.1	12.1	10.6	9.4	8.5	7.7	7.1	6.5	6.1	5.6
#9	1 1/4	68.6	34.3	22.9	17.2	13.7	11.4	9.8	8.6	7.6	6.9	6.2	5.7	5.3	4.9	4.6
#10 or 30M	1 3/8	56.7	28.4	18.9	14.2	11.3	9.5	8.1	7.1	6.3	5.7	5.2	4.7	4.4	4.1	3.8
#11	1 3/4	35.0	17.5	11.7	8.8	7.0	5.8	5.0	4.4	3.9	3.5	3.2	2.9	2.7	2.5	2.3

* The number of anchoring installations is based upon calculations of hole volumes using ANSI tolerance carbide tipped drill bits, the nominal areas of the reinforcing bars and the stress areas of the threaded rods. These estimates do not account for waste.

ESTIMATING TABLE

A7+

28 Fluid Ounce Cartridge

Number of Anchoring Installations per Cartridge* Using Threaded Rod with A7+ Adhesive in Solid Concrete

THREADED ROD	DRILL HOLE DIA. INCHES	EMBEDMENT DEPTH IN INCHES (mm)														
		1 (25.4)	2 (50.8)	3 (76.2)	4 (101.6)	5 (127.0)	6 (152.4)	7 (177.8)	8 (203.2)	9 (228.6)	10 (254.0)	11 (279.4)	12 (304.8)	13 (330.2)	14 (355.6)	15 (381.0)
1/4	5/16	1098.2	549.1	366.1	274.6	219.6	183.0	156.9	137.3	122.0	109.8	99.8	91.5	84.5	78.4	73.2
3/8	7/16	560.3	280.2	186.8	140.1	112.1	93.4	80.0	70.0	62.3	56.0	50.9	46.7	43.1	40.0	37.4
1/2	9/16	339.0	169.5	113.0	84.7	67.8	56.5	48.4	42.4	37.7	33.9	30.8	28.2	26.1	24.2	22.6
5/8	11/16	226.9	113.5	75.6	56.7	45.4	37.8	32.4	28.4	25.2	22.7	20.6	18.9	17.5	16.2	15.1
	3/4	190.7	95.3	63.6	47.7	38.1	31.8	27.2	23.8	21.2	19.1	17.3	15.9	14.7	13.6	12.7
3/4	13/16	162.5	81.2	54.2	40.6	32.5	27.1	23.2	20.3	18.1	16.2	14.8	13.5	12.5	11.6	10.8
	7/8	140.1	70.0	46.7	35.0	28.0	23.3	20.0	17.5	15.6	14.0	12.7	11.7	10.8	10.0	9.3
7/8	15/16	122.0	61.0	40.7	30.5	24.4	20.3	17.4	15.3	13.6	12.2	11.1	10.2	9.4	8.7	8.1
	1	107.2	53.6	35.7	26.8	21.4	17.9	15.3	13.4	11.9	10.7	9.7	8.9	8.2	7.7	7.1
1	1-1/16	95.0	47.5	31.7	23.8	19.0	15.8	13.6	11.9	10.6	9.5	8.6	7.9	7.3	6.8	6.3
	1-1/8	84.7	42.4	28.2	21.2	16.9	14.1	12.1	10.6	9.4	8.5	7.7	7.1	6.5	6.1	5.6
1-1/4	1-1/3	62.3	31.1	20.8	15.6	12.5	10.4	8.9	7.8	6.9	6.2	5.7	5.2	4.8	4.4	4.2
	1-3/8	56.7	28.4	18.9	14.2	11.3	9.5	8.1	7.1	6.3	5.7	5.2	4.7	4.4	4.1	3.8

* The number of anchoring installations is based upon calculations of hole volumes using ANSI tolerance carbide tipped drill bits, the nominal areas of the reinforcing bars and the stress areas of the threaded rods. These estimates do not account for waste.

A7P-10 fl. oz. Ordering Information

PART NUMBER	DESCRIPTION	BOX QTY
 A7P-10	9.5 Fluid Ounce Cartridge with nozzle	6
 A24S	Mixing Nozzle for A7P-10 Cartridge Nozzle diameter fits 3/8" to 5/8" holes (overall length of nozzle 6-3/8")	24
 A100	Hand Dispenser for A7P-10 Cartridge (26:1 Thrust Ratio)	1

Refer to page RH 34 for ordering information on wire brushes, brush extensions, and blow pump for deep holes.

PACKAGING

1. Disposable, self-contained cartridge system capable of dispensing both components in the proper mixing ratio
2. The two components are dispensed through a static mixing nozzle that thoroughly mixes the material and places the material at the base of the pre-drilled hole
3. Cartridge markings: Include manufacturer's name, batch number and best-used-by date, mix ratio by volume, ANSI hazard classification, and appropriate ANSI handling precautions

SUGGESTED SPECIFICATIONS

HYBRID ADHESIVE:

High Strength HYBRID ADHESIVE: ARRA Certified

1. Two component vinyl ester adhesive, non-sag paste, moisture insensitive when cured, dark gray in color, fast cure times.
2. Meets NSF Standard 61, certified for use in conjunction with drinking water systems.
3. Works in wet, damp, submerged holes.
4. Shelf life: Best if used within 18 months.
5. All weather, cure time (45 min. at 21°C).
6. Dispenses easier and faster.
7. Dispenses and cures faster in hot weather, but works in cold weather.
8. Pumpable at -10°C without preheating.
9. Formula for use in solid and hollow base materials.
10. Suitable for oversized and diamond cored holes with increased depths.
11. Quick insertion time = less labor cost.

ESTIMATING TABLES

A7+ 9.5 Fluid Ounce Cartridge

Number of Anchoring Installations per Cartridge* Using Reinforcing Bar and Threaded Rod with A7+ Adhesive in Solid Concrete

REBAR	DRILL HOLE DIA. INCHES	EMBEDMENT DEPTH IN INCHES (mm)			
		2 (50.8)	4 (101.6)	6 (152.4)	8 (203.2)
# 3	7/16	100.1	50.0	33.4	25.0
# 4	5/8	49.0	24.5	16.3	12.3
# 5	3/4	34.0	17.0	11.3	8.5
# 6	7/8	25.0	12.5	8.3	6.3
# 7	1	19.2	9.6	6.4	4.8
# 8	1-1/8	15.1	7.6	5.0	3.8

* The number of anchoring installations is based upon calculations of hole volumes using ANSI tolerance carbide tipped drill bits, the nominal areas of the reinforcing bars and the stress areas of the threaded rods. These estimates do not account for waste.

Rod In. (mm)	DRILL HOLE DIA. INCHES	EMBEDMENT DEPTH IN INCHES (mm)			
		2 (50.8)	4 (101.6)	6 (152.4)	8 (203.2)
3/8 (9.5)	7/16	100.1	50.0	33.4	25.0
1/2 (12.7)	9/16	60.5	30.3	20.2	15.1
5/8 (15.9)	11/16	40.5	20.3	13.5	10.1
	3/4	34.0	17.0	11.3	8.5
3/4 (19.1)	13/16	29.0	14.5	9.7	7.3
	7/8	25.0	12.5	8.3	6.3
7/8 (22.2)	15/16	21.8	10.9	7.3	5.4
	1	19.2	9.6	6.4	4.8
1 (25.4)	1-1/16	17.0	8.5	5.7	4.2
	1-1/8	15.1	7.6	5.0	3.8

PERFORMANCE TABLES

A7+ Hybrid Adhesive

Factored Steel Strength for Threaded Rod

Threaded Rod Dia. In. (mm)	Tension kN (lb), Nsar ³			Shear kN (lb) Vsar ⁴			Seismic Shear kN (lb), Vsar,seismic ⁵		
	Carbon Steel A36 ¹	Carbon Steel A193 B7 ¹	Stainless F593 ²	Carbon Steel A36 ¹	Carbon Steel A193 B7 ¹	Stainless F593 ²	Carbon Steel A36 ¹	Carbon Steel A193 B7 ¹	Stainless F593 ²
3/8 (9.5)	14 (3,060)	29 (6,589)	19 (4,382)	6 (1,434)	14 (3,089)	9 (2,033)	4 (1,004)	10 (2,162)	6 (1,423)
1/2 (12.7)	25 (5,596)	54 (12,063)	36 (8,021)	14 (3,149)	30 (6,783)	17 (3,724)	10 (2,204)	21 (4,748)	12 (2,607)
5/8 (15.9)	40 (8,915)	85 (19,210)	57 (12,775)	22 (5,017)	48 (10,806)	26 (5,931)	16 (3,512)	34 (7,564)	18 (4,152)
3/4 (19.1)	59 (13,192)	126 (28,431)	67 (15,104)	33 (7,421)	71 (15,995)	31 (7,011)	23 (5,194)	50 (11,196)	22 (4,908)
7/8 (22.2)	81 (18,210)	175 (39,243)	93 (20,890)	46 (10,245)	98 (22,077)	43 (9,699)	32 (7,171)	69 (15,454)	30 (6,789)
1 (25.4)	106 (23,888)	229 (51,483)	122 (27,403)	60 (13,439)	129 (28,962)	57 (12,724)	42 (9,407)	90 (20,273)	40 (8,907)
1-1/4 (31.8)	170 (38,223)	366 (82,375)	195 (43,819)	96 (21,503)	206 (46,334)	90 (20,343)	67 (15,052)	144 (32,433)	63 (14,240)

1 Values correspond to a ductile steel element

3 Tension values calculated according to Cl. D6.1.2 in CSA A23.3-14 Annex D

5 Seismic shear was calculated according to Vsar*aV,seis

2 Values correspond to a brittle steel element

4 Shear values calculated according to Cl. D7.1.2 in CSA A23.3-14 Annex D

A7+ Hybrid Adhesive

Concrete Breakout and Bond Strength for Threaded Rod

Nominal Anchor Diameter	Symbol	Units	Nominal Rod Diameter In. (mm)							
			3/8 (9.5)	1/2 (12.7)	5/8 (15.9)	3/4 (19.1)	7/8 (22.2)	1 (25.4)	1-1/4 (31.8)	
Concrete Breakout										
Effectiveness factor for uncracked concrete	k_{uncr}	–	10							
Effectiveness factor for cracked concrete	k_{cr}	–	7							
Modification factor for cracked and uncracked	$\psi_{c,N}$	–	1							
Minimum concrete thickness	h_{min}	mm	$h_{ef} + 31.75$			$h_{ef} + 2d$				
Anchor embedment depth – minimum	$h_{ef,min}$	mm	60.3	69.9	79.4	88.9	88.9	101.6	127.0	
Minimum spacing	s_{min}	mm	23.8	38.1	63.5	76.2	88.9	101.6	127.0	
Minimum edge distance	c_{min}	mm	23.8	38.1	63.5	76.2	88.9	101.6	127.0	
Critical edge distance	c_{ac}	mm	See Section 4.1.10 of the evaluation report ESR 3903							
Material resistance factor for concrete	Φ_c	–	0.65							
Strength reduction factor for tension, concrete failure modes ^{3,4}	R	Cond. A	1.15							
	R	Cond. B	1							
Strength reduction factor for shear, concrete failure modes ^{3,4}	R	Cond. A	1.15							
	R	Cond. B	1							
Modification Factor for concrete density	λ	–	1							
Bond Strength										
			Nominal Rod Diameter In. (mm)							
			3/8 (9.5)	1/2 (12.7)	5/8 (15.9)	3/4 (19.1)	7/8 (22.2)	1 (25.4)	1-1/4 (31.8)	
Temperature Range A ¹	Characteristic Bond Strength for Uncracked Concrete	$T_{k,uncr}$	MPa (psi)	12.2 (1770)	12.2 (1770)	12.2 (1770)	12.2 (1770)	10.3 (1490)	10.3 (1490)	10.3 (1490)
	Characteristic Bond Strength for Cracked Concrete	$T_{k,cr}$	MPa (psi)	7.3 (1060)	5.4 (790)	5.9 (860)	6.1 (885)	4.8 (695)	4.5 (655)	4.0 (585)
Temperature Range B ²	Characteristic Bond Strength for Uncracked Concrete	$T_{k,uncr}$	MPa (psi)	8.8 (1275)	8.8 (1275)	8.8 (1275)	8.8 (1275)	7.4 (1080)	7.4 (1080)	7.4 (1080)
	Characteristic Bond Strength for Cracked Concrete	$T_{k,cr}$	MPa (psi)	5.3 (1080)	3.9 (570)	4.3 (620)	4.4 (640)	3.4 (500)	3.3 (475)	2.9 (420)
Continuous Inspection	Strength Reduction Factor – Dry Concrete	$\Phi_{dry,ci}$	–	0.65	0.65	0.65	0.65	0.65	0.65	0.65
	Strength Reduction Factor – Water-Saturated Concrete	$\Phi_{sat,ci}$	–	0.65	0.65	0.65	0.65	0.65	0.65	0.65
	Strength Reduction Factor – Water-Filled Holes	$\Phi_{wf,ci}$	–	0.65	0.65	0.65	0.65	0.65	0.65	0.65
	Strength Reduction Factor – Submerged Concrete	$\Phi_{sub,ci}$	–	0.65	0.55	0.55	0.65	0.65	0.55	0.65
Periodic Inspection	Strength Reduction Factor – Dry Concrete	$\Phi_{dry,pi}$	–	0.55	0.55	0.55	0.55	0.55	0.55	0.65
	Strength Reduction Factor – Water-Saturated Concrete	$\Phi_{sat,pi}$	–	0.65	0.65	0.65	0.65	0.65	0.65	0.65
	Strength Reduction Factor – Water-Filled Holes	$\Phi_{wf,pi}$	–	0.65	0.65	0.65	0.65	0.65	0.65	0.65
	Strength Reduction Factor – Submerged Concrete	$\Phi_{sub,pi}$	–	0.65	0.45	0.45	0.65	0.55	0.45	0.65
Reduction factor for seismic tension		$a_{N,seis}$	–	0.89	0.75	0.76	0.66	0.77	0.80	0.80

1 Temperature Range A: Max short term temperature = 130°F (55°C), max long term temperature = 110°F (43°C)

2 Temperature Range B: Max short term temperature = 176°F (80°C), max long term temperature = 110°F (43°C)

3 Condition A applies where the potential concrete failure surfaces are crossed by supplementary reinforcement proportioned to tie the potential concrete failure prism into the structural member except where pullout or pryout resistance governs

4 Condition B applies where supplementary reinforcement is not provided or where pullout or pryout strength governs

PERFORMANCE TABLES

A7+ Hybrid Adhesive Factored Steel Strength for Reinforcing Bars, kN (lbf)

US Rebar Size	ASTM A615 Grade 60 Rebar			CA Rebar Size	CSA G30.18 Grade 400		
	Tension kN (lb)	Shear kN (lb)	Seismic Shear kN (lb)		Tension kN (lb)	Shear kN (lb)	Seismic Shear kN (lb)
No. 3	29.9 (6,732)	16.8 (3,787)	135.6 (3,446)	10M	37 (8,255)	21 (4,643)	14 (3,250)
No. 4	54.4 (12,240)	30.6 (6,885)	28.0 (6,265)	15M	73 (16,510)	41 (9,287)	29 (6,501)
No. 5	84.4 (18,972)	47.5 (10,672)	43.0 (9,711)	20M	110 (24,765)	62 (13,930)	43 (9,751)
No. 6	119.8 (26,928)	67.4 (15,147)	61.0 (13,632)	25M	184 (41,275)	103 (23,217)	72 (16,252)
No. 7	163.3 (36,720)	91.9 (20,655)	83.0 (18,590)	30M	257 (57,785)	145 (32,504)	101 (22,753)
No. 8	215.1 (48,348)	121.0 (27,196)	86.0 (19,309)				
No. 9	272.2 (61,200)	153.1 (34,425)	109.0 (24,442)				
No. 10	345.7 (77,724)	194.5 (43,720)	138.0 (31,041)				

1 Values correspond to a ductile steel element per standards above
 2 Tension values calculated according to Cl. D6.1.2 in CSA A23.3-14 Annex D
 3 Shear values calculated according to Cl. D7.1.2 in CSA A23.3-14 Annex D
 4 Seismic shear was calculated according to $V_{sar} \cdot a_{V,seis}$

A7+ Hybrid Adhesive Concrete Breakout and Bond Strength for Rebar

Nominal Anchor Size	Symbol	Units	Reinforcing Steel Bar Size									
	do		No. 3	No. 4	No. 5	No. 6	No. 7	No. 8	No. 9	No. 9		
Concrete Breakout												
Effectiveness factor for uncracked concrete	k_{uncr}	–	10									
Effectiveness factor for cracked concrete	k_{cr}	–	7									
Minimum concrete thickness	h_{min}	mm	$h_{ef} + 31.75$					$h_{ef} + 2do$				
Anchor embedment depth – minimum	$h_{ef,min}$	mm	60.3	69.9	79.4	88.9	88.9	101.6	114.3	127.0		
Minimum spacing	s_{min}	mm	23.8	38.1	63.5	76.2	88.9	101.6	114.3	127.0		
Minimum edge distance	c_{min}	mm	23.8	38.1	63.5	76.2	88.9	101.6	114.3	127.0		
Critical edge distance	c_{ac}	mm	See Section 4.1.10 of the evaluation report ESR 3903									
Material resistance factor for concrete	Φ_c	–	0.65									
Strength reduction factor for tension, concrete failure modes ^{3,4}	R	Cond. A	1.15									
	R	Cond. B	1									
Strength reduction factor for shear, concrete failure modes ^{3,4}	R	Cond. A	1.15									
	R	Cond. B	1									
Modification Factor for concrete density	λ	–	1									
Bond Strength												
Nominal Anchor Size			No. 3	No. 4	No. 5	No. 6	No. 7	No. 8	No. 9	No. 10		
Temperature Range A ¹	Characteristic Bond Strength for Uncracked Concrete	$T_{k,uncr}$	MPa (psi)	11.5 (1675)	13.3 (1935)	13.1 (1900)	11.7 (1700)	11.3 (1635)	11.1 (1615)	10.9 (1585)	10.7 (1550)	
	Characteristic Bond Strength for Cracked Concrete	$T_{k,cr}$	MPa (psi)	5.2 (755)	5.2 (755)	5.2 (755)	4.0 (585)	4.0 (585)	4.0 (585)	4.0 (585)	4.2 (605)	
Temperature Range B ^{2,4}	Characteristic Bond Strength for Uncracked Concrete	$T_{k,uncr}$	MPa (psi)	8.3 (1210)	9.6 (1395)	9.5 (1210)	8.5 (1230)	8.1 (1180)	8.0 (1165)	7.9 (1145)	7.7 (1120)	
	Characteristic Bond Strength for Cracked Concrete	$T_{k,cr}$	MPa (psi)	3.8 (545)	3.8 (545)	3.8 (545)	2.9 (420)	2.9 (420)	2.9 (420)	2.9 (420)	3.0 (435)	
Continuous Inspection	Strength Reduction Factor – Dry Concrete	$\Phi_{dry,ci}$	–	0.65	0.65	0.65	0.65	0.65	0.65	0.65	0.65	
	Strength Reduction Factor – Water-Saturated Concrete	$\Phi_{sat,ci}$	–	0.65	0.65	0.65	0.65	0.65	0.65	0.65	0.65	
	Strength Reduction Factor – Water-Filled Holes	$\Phi_{wf,ci}$	–	0.65	0.65	0.65	0.65	0.65	0.65	0.65	0.65	
	Strength Reduction Factor – Submerged Concrete	$\Phi_{sub,ci}$	–	0.65	0.55	0.55	0.65	0.65	0.55	0.55	0.65	
Periodic Inspection	Strength Reduction Factor – Dry Concrete	$\Phi_{dry,pi}$	–	0.55	0.55	0.55	0.55	0.55	0.55	0.55	0.65	
	Strength Reduction Factor – Water-Saturated Concrete	$\Phi_{sat,pi}$	–	0.65	0.65	0.65	0.65	0.65	0.65	0.65	0.65	
	Strength Reduction Factor – Water-Filled Holes	$\Phi_{wf,pi}$	–	0.65	0.65	0.65	0.65	0.65	0.65	0.65	0.65	
	Strength Reduction Factor – Submerged Concrete	$\Phi_{sub,pi}$	–	0.65	0.45	0.45	0.65	0.55	0.45	0.45	0.65	
Reduction factor for seismic tension	$a_{N,seis}$	–	0.92	0.92	0.92	0.82	0.82	0.82	0.82	0.82		

1 Temperature Range A: Max short term temperature = 130°F (55°C), max long term temperature = 110°F (43°C)

2 Temperature Range B: Max short term temperature = 176°F (80°C), max long term temperature = 110°F (43°C)

3 Condition A applies where the potential concrete failure surfaces are crossed by supplementary reinforcement proportioned to tie the potential concrete failure prism into the structural member except where pullout or pryout resistance governs

4 Condition B applies where supplementary reinforcement is not provided or where pullout or pryout strength governs

Combined Tension and Shear Loading—for A7+ Adhesive Anchors

Allowable loads for anchors under tension and shear loading at the same time (combined loading) will be lower than the allowable loads for anchors subjected to 100% tension or 100% shear. For combined tension and shear loading, please see Section 4.2.2 of ICC ESR 3903

PERFORMANCE TABLES

A7+ Hybrid Adhesive

Factored Concrete Breakout/Bond Failure Strength for Threaded Rod Tension, kN (lbf)

Nominal anchor diameter In. (mm)	Effective Embedment In. (mm)	UNCRACKED			CRACKED		
		f'c = 20 Mpa (2900 psi)	f'c = 30 Mpa (4350 psi)	f'c = 40 Mpa (5800 psi)	f'c = 20 Mpa (2900 psi)	f'c = 30 Mpa (4350 psi)	f'c = 40 Mpa (5800 psi)
3/8 (9.5)	2-3/8 (60)	13.6 (3,060)	14.3 (3,215)	14.3 (3,215)	8.6 (1,925)	8.6 (1,925)	8.6 (1,925)
	3-3/8 (86)	20.3 (4,570)	20.3 (4,570)	20.3 (4,570)	12.2 (2,735)	12.2 (2,735)	12.2 (2,735)
	4-1/2 (114)	27.1 (6,095)	27.1 (6,095)	27.1 (6,095)	16.2 (3,645)	16.2 (3,645)	16.2 (3,645)
	7-1/2 (191)	45.2 (10,160)	45.2 (10,160)	45.2 (10,160)	27.0 (6,075)	27.0 (6,075)	27.0 (6,075)
1/2 (12.7)	2-3/4 (70)	17.0 (3,815)	20.8 (4,670)	22.1 (4,965)	9.9 (2,220)	9.9 (2,220)	9.9 (2,220)
	4-1/2 (114)	35.5 (7,985)	36.2 (8,130)	36.2 (8,130)	16.1 (3,630)	16.1 (3,630)	16.1 (3,630)
	6 (152)	48.2 (10,835)	48.2 (10,835)	48.2 (10,835)	21.5 (4,840)	21.5 (4,840)	21.5 (4,840)
	10 (254)	80.3 (18,060)	80.3 (18,060)	80.3 (18,060)	35.9 (8,065)	35.9 (8,065)	35.9 (8,065)
5/8 (15.9)	3-1/8 (79)	20.6 (4,620)	25.2 (5,660)	29.1 (6,535)	14.4 (3,235)	15.2 (3,425)	15.2 (3,425)
	5-5/8 (143)	49.6 (11,160)	56.5 (12,700)	56.5 (12,700)	27.4 (6,165)	27.4 (6,165)	27.4 (6,165)
	7-1/2 (191)	75.3 (16,935)	75.3 (16,935)	75.3 (16,935)	36.6 (8,220)	36.6 (8,220)	36.6 (8,220)
	12-1/2 (318)	125.5 (28,220)	125.5 (28,220)	125.5 (28,220)	61.0 (13,705)	61.0 (13,705)	61.0 (13,705)
3/4 (19.1)	3-1/2 (89)	24.4 (5,480)	29.8 (6,710)	34.5 (7,745)	17.1 (3,835)	20.9 (4,695)	21.1 (4,755)
	6-3/4 (171)	65.3 (14,670)	79.9 (17,970)	81.3 (18,290)	40.8 (9,170)	40.8 (9,170)	40.8 (9,170)
	9 (229)	100.5 (22,585)	108.5 (24,385)	108.5 (24,385)	54.4 (12,225)	54.4 (12,225)	54.4 (12,225)
	15 (381)	180.8 (40,640)	180.8 (40,640)	180.8 (40,640)	90.6 (20,375)	90.6 (20,375)	90.6 (20,375)
7/8 (22.2)	3-1/2 (89)	24.4 (5,480)	29.8 (6,710)	34.5 (7,745)	17.1 (3,835)	19.3 (4,335)	19.3 (4,335)
	7-7/8 (200)	82.2 (18,485)	93.4 (20,995)	93.4 (20,995)	43.4 (9,750)	43.4 (9,750)	43.4 (9,750)
	10-1/2 (267)	124.5 (27,990)	124.5 (27,990)	124.5 (27,990)	57.8 (13,000)	57.8 (13,000)	57.8 (13,000)
	17-1/2 (445)	207.5 (46,655)	207.5 (46,655)	207.5 (46,655)	96.4 (21,670)	96.4 (21,670)	96.4 (21,670)
1 (25.4)	4 (102)	29.8 (6,690)	36.5 (8,195)	42.1 (9,465)	20.8 (4,685)	23.8 (5,350)	23.8 (5,350)
	9 (229)	100.5 (22,585)	122.0 (27,420)	122.0 (27,420)	53.5 (12,040)	53.5 (12,040)	53.5 (12,040)
	12 (305)	154.7 (34,775)	162.6 (36,560)	162.6 (36,560)	71.4 (16,050)	71.4 (16,050)	71.4 (16,050)
	20 (508)	271.0 (60,935)	271.0 (60,935)	271.0 (60,935)	119.0 (26,750)	119.0 (26,750)	119.0 (26,750)
1-1/4 (31.8)	5 (127)	41.6 (9,355)	51.0 (11,455)	58.8 (13,225)	29.1 (6,545)	33.1 (7,440)	33.1 (7,440)
	11-1/4 (286)	140.4 (31,565)	172.0 (38,660)	190.6 (42,845)	74.5 (16,740)	74.5 (16,740)	74.5 (16,740)
	15 (381)	216.2 (48,600)	254.1 (57,125)	254.1 (57,125)	99.3 (22,320)	99.3 (22,320)	99.3 (22,320)
	25 (635)	423.5 (95,210)	423.5 (95,210)	423.5 (95,210)	165.5 (37,205)	165.5 (37,205)	165.5 (37,205)

A7+ Hybrid Adhesive

Factored Concrete Breakout/Bond Failure Strength for Threaded Rod Shear, kN (lbf)

Nominal anchor diameter In. (mm)	Effective Embedment In. (mm)	UNCRACKED			CRACKED		
		f'c = 20 Mpa (2900 psi)	f'c = 30 Mpa (4350 psi)	f'c = 40 Mpa (5800 psi)	f'c = 20 Mpa (2900 psi)	f'c = 30 Mpa (4350 psi)	f'c = 40 Mpa (5800 psi)
3/8 (9.5)	2-3/8 (60)	13.6 (3,060)	14.3 (3,215)	14.3 (3,215)	8.6 (1,925)	8.6 (1,925)	8.6 (1,925)
	3-3/8 (86)	40.7 (9,145)	40.7 (9,145)	40.7 (9,145)	24.3 (5,470)	24.3 (5,470)	24.3 (5,470)
	4-1/2 (114)	54.2 (12,190)	54.2 (12,190)	54.2 (12,190)	32.4 (7,290)	32.4 (7,290)	32.4 (7,290)
	7-1/2 (191)	90.4 (20,320)	90.4 (20,320)	90.4 (20,320)	54.1 (12,155)	54.1 (12,155)	54.1 (12,155)
1/2 (12.7)	2-3/4 (70)	33.9 (7,630)	41.6 (9,345)	44.2 (9,935)	19.7 (4,435)	19.7 (4,435)	19.7 (4,435)
	4-1/2 (114)	71.0 (15,970)	72.3 (16,255)	72.3 (16,255)	32.3 (7,260)	32.3 (7,260)	32.3 (7,260)
	6 (152)	96.4 (21,675)	96.4 (21,675)	96.4 (21,675)	43.1 (9,680)	43.1 (9,680)	43.1 (9,680)
	10 (254)	160.7 (36,125)	160.7 (36,125)	160.7 (36,125)	71.8 (16,130)	71.8 (16,130)	71.8 (16,130)
5/8 (15.9)	3-1/8 (79)	41.1 (9,245)	50.4 (11,320)	58.1 (13,070)	28.8 (6,470)	30.5 (6,855)	30.5 (6,855)
	5-5/8 (143)	99.3 (22,320)	113.0 (25,400)	113.0 (25,400)	54.9 (12,335)	54.9 (12,335)	54.9 (12,335)
	7-1/2 (191)	150.6 (33,865)	150.6 (33,865)	150.6 (33,865)	73.1 (16,445)	73.1 (16,445)	73.1 (16,445)
	12-1/2 (318)	251.1 (56,445)	251.1 (56,445)	251.1 (56,445)	121.9 (27,410)	121.9 (27,410)	121.9 (27,410)
3/4 (19.1)	3-1/2 (89)	48.7 (10,955)	59.7 (13,420)	68.9 (15,495)	34.1 (7,670)	41.8 (9,390)	42.3 (9,510)
	6-3/4 (171)	130.5 (29,340)	159.8 (35,935)	162.7 (36,575)	81.6 (18,340)	81.6 (18,340)	81.6 (18,340)
	9 (229)	200.9 (45,175)	216.9 (48,765)	216.9 (48,765)	108.8 (24,450)	108.8 (24,450)	108.8 (24,450)
	15 (381)	361.5 (81,280)	361.5 (81,280)	361.5 (81,280)	181.3 (40,755)	181.3 (40,755)	181.3 (40,755)
7/8 (22.2)	3-1/2 (89)	48.7 (10,955)	59.7 (13,420)	68.9 (15,495)	34.1 (7,670)	38.6 (8,670)	38.6 (8,670)
	7-7/8 (200)	164.5 (36,975)	186.8 (41,990)	186.8 (41,990)	86.8 (19,500)	86.8 (19,500)	86.8 (19,500)
	10-1/2 (267)	249.0 (55,985)	249.0 (55,985)	249.0 (55,985)	115.7 (26,005)	115.7 (26,005)	115.7 (26,005)
	17-1/2 (445)	415.0 (93,305)	415.0 (93,305)	415.0 (93,305)	192.8 (43,340)	192.8 (43,340)	192.8 (43,340)
1 (25.4)	4 (102)	59.5 (13,385)	72.9 (16,395)	84.2 (18,930)	41.7 (9,370)	47.6 (10,700)	47.6 (10,700)
	9 (229)	200.9 (45,175)	243.9 (54,840)	243.9 (54,840)	107.1 (24,075)	107.1 (24,075)	107.1 (24,075)
	12 (305)	309.4 (69,550)	325.3 (73,120)	325.3 (73,120)	142.8 (32,100)	142.8 (32,100)	142.8 (32,100)
	20 (508)	542.1 (121,870)	542.1 (121,870)	542.1 (121,870)	238.0 (53,500)	238.0 (53,500)	238.0 (53,500)
1-1/4 (31.8)	5 (127)	83.2 (18,705)	101.9 (22,910)	117.7 (26,455)	58.2 (13,095)	66.2 (14,880)	66.2 (14,880)
	11-1/4 (286)	280.8 (63,135)	343.9 (77,320)	381.2 (85,690)	148.9 (33,485)	148.9 (33,485)	148.9 (33,485)
	15 (381)	432.4 (97,200)	508.2 (114,250)	508.2 (114,250)	198.6 (44,645)	198.6 (44,645)	198.6 (44,645)
	25 (635)	847.0 (190,420)	847.0 (190,420)	847.0 (190,420)	331.0 (74,405)	331.0 (74,405)	331.0 (74,405)

1 These load values are for the purposes of estimation only and should not be used in design
 2 Assuming single anchor with no edge or spacing distances, nor environmental factors that would reduce the load.
 3 Design loads include their respective ϕ_c and ϕ_s material resistance factors for concrete and steel from CSA A23.3-14 Cl. 8.4.2 and 8.4.3
 4 Design loads include their respective strength reduction factor for dry, water saturated and water filled hole conditions. Refer to design information table for threaded rod for submerged conditions (ϕ_{sub}).

5 All design loads are calculated according to Condition B for concrete failure mode factor R
 6 Temperature Range A (long term temperature 43°C, short term temperature 55°C)
 7 Temperature Range B (long term temperature 43°C, short term temperature 80°C)
 8 Values for continuous inspection with dry, water saturated or water filled concrete

PERFORMANCE TABLES

A7+ Hybrid Adhesive

**Factored Concrete Breakout/Bond Failure Strength for Reinforcing Bars
Tension, kN (lbf)**

US Rebar Size (mm)	Effective Embedment In. (mm)	UNCRACKED			CRACKED		
		f'c = 20 Mpa (2900 psi)	f'c = 30 Mpa (4350 psi)	f'c = 40 Mpa (5800 psi)	f'c = 20 Mpa (2900 psi)	f'c = 30 Mpa (4350 psi)	f'c = 40 Mpa (5800 psi)
# 3 (9.5)	3-1/2 (89)	20.0 (4,490)	20.0 (4,490)	20.0 (4,490)	9.0 (2,020)	9.0 (2,020)	9.0 (2,020)
	4-1/2 (114)	25.7 (5,770)	25.7 (5,770)	25.7 (5,770)	11.5 (2,595)	11.5 (2,595)	11.5 (2,595)
	7-1/2 (191)	42.8 (9,620)	42.8 (9,620)	42.8 (9,620)	19.2 (4,325)	19.2 (4,325)	19.2 (4,325)
# 4 (12.7)	4-1/2 (114)	35.5 (7,985)	39.5 (8,885)	39.5 (8,885)	15.4 (3,460)	15.4 (3,460)	15.4 (3,460)
	6 (152)	52.7 (11,850)	52.7 (11,850)	52.7 (11,850)	20.5 (4,615)	20.5 (4,615)	20.5 (4,615)
	10 (254)	87.8 (19,745)	87.8 (19,745)	87.8 (19,745)	34.2 (7,690)	34.2 (7,690)	34.2 (7,690)
# 5 (15.9)	5-3/4 (146)	51.3 (11,535)	62.0 (13,930)	62.0 (13,930)	24.6 (5,525)	24.6 (5,525)	24.6 (5,525)
	7-1/2 (191)	76.4 (17,185)	80.8 (18,170)	80.8 (18,170)	32.1 (7,210)	32.1 (7,210)	32.1 (7,210)
	12-1/2 (318)	134.7 (30,280)	134.7 (30,280)	134.7 (30,280)	53.4 (12,015)	53.4 (12,015)	53.4 (12,015)
# 6 (19.1)	6-3/4 (171)	65.3 (14,670)	78.2 (17,575)	78.2 (17,575)	26.9 (6,050)	26.9 (6,050)	26.9 (6,050)
	9 (229)	100.5 (22,585)	104.2 (23,430)	104.2 (23,430)	35.9 (8,065)	35.9 (8,065)	35.9 (8,065)
	15 (381)	173.7 (39,055)	173.7 (39,055)	173.7 (39,055)	59.8 (13,440)	59.8 (13,440)	59.8 (13,440)
# 7 (22.2)	8 (203)	84.2 (18,930)	103.1 (23,185)	104.0 (23,370)	37.2 (8,360)	37.2 (8,360)	37.2 (8,360)
	10-1/2 (267)	126.6 (28,465)	136.4 (30,675)	136.4 (30,675)	48.8 (10,975)	48.8 (10,975)	48.8 (10,975)
	17-1/2 (445)	227.4 (51,125)	227.4 (51,125)	227.4 (51,125)	81.4 (18,290)	81.4 (18,290)	81.4 (18,290)
# 8 (25.4)	9 (229)	100.5 (22,585)	123.1 (27,665)	131.9 (29,645)	47.8 (10,750)	47.8 (10,750)	47.8 (10,750)
	13 (330)	174.4 (39,210)	190.5 (42,820)	190.5 (42,820)	69.1 (15,530)	69.1 (15,530)	69.1 (15,530)
	20 (508)	293.0 (65,875)	293.0 (65,875)	293.0 (65,875)	106.3 (23,890)	106.3 (23,890)	106.3 (23,890)
# 9 (28.6)	10-1/2 (267)	126.6 (28,465)	155.1 (34,860)	170.1 (38,235)	62.8 (14,110)	62.8 (14,110)	62.8 (14,110)
	13-1/2 (343)	184.6 (41,495)	218.7 (49,155)	218.7 (49,155)	80.7 (18,145)	80.7 (18,145)	80.7 (18,145)
	20 (508)	323.9 (72,825)	323.9 (72,825)	323.9 (72,825)	119.6 (26,880)	119.6 (26,880)	119.6 (26,880)
# 10 (32.2)	12 (305)	154.7 (34,775)	189.5 (42,590)	211.1 (47,445)	82.2 (18,470)	82.2 (18,470)	82.2 (18,470)
	15 (381)	216.2 (48,600)	263.8 (59,310)	263.8 (59,310)	102.7 (23,090)	102.7 (23,090)	102.7 (23,090)
	25 (635)	439.7 (98,850)	439.7 (98,850)	439.7 (98,850)	171.2 (38,480)	171.2 (38,480)	171.2 (38,480)

A7+ Hybrid Adhesive

**Factored Concrete Breakout/Bond Failure Strength for Reinforcing Bars
Shear, kN (lbf)**

US Rebar Size (mm)	Effective Embedment In. (mm)	UNCRACKED			CRACKED		
		f'c = 20 Mpa (2900 psi)	f'c = 30 Mpa (4350 psi)	f'c = 40 Mpa (5800 psi)	f'c = 20 Mpa (2900 psi)	f'c = 30 Mpa (4350 psi)	f'c = 40 Mpa (5800 psi)
# 3 (9.5)	3-1/2 (89)	39.9 (8,980)	39.9 (8,980)	39.9 (8,980)	18.0 (4,035)	18.0 (4,035)	18.0 (4,035)
	4-1/2 (114)	51.3 (11,545)	51.3 (11,545)	51.3 (11,545)	23.1 (5,190)	23.1 (5,190)	23.1 (5,190)
	7-1/2 (191)	85.6 (19,240)	85.6 (19,240)	85.6 (19,240)	38.5 (8,650)	38.5 (8,650)	38.5 (8,650)
# 4 (12.7)	4-1/2 (114)	71.0 (15,970)	79.1 (17,770)	79.1 (17,770)	30.8 (6,920)	30.8 (6,920)	30.8 (6,920)
	6 (152)	105.4 (23,695)	105.4 (23,695)	105.4 (23,695)	41.0 (9,225)	41.0 (9,225)	41.0 (9,225)
	10 (254)	175.7 (39,495)	175.7 (39,495)	175.7 (39,495)	68.4 (15,375)	68.4 (15,375)	68.4 (15,375)
# 5 (15.9)	5-3/4 (146)	102.6 (23,070)	123.9 (27,855)	123.9 (27,855)	49.2 (11,050)	49.2 (11,050)	49.2 (11,050)
	7-1/2 (191)	152.9 (34,365)	161.6 (36,335)	161.6 (36,335)	64.1 (14,415)	64.1 (14,415)	64.1 (14,415)
	12-1/2 (318)	269.4 (60,560)	269.4 (60,560)	269.4 (60,560)	106.9 (24,025)	106.9 (24,025)	106.9 (24,025)
# 6 (19.1)	6-3/4 (171)	130.5 (29,340)	156.3 (35,150)	156.3 (35,150)	53.8 (12,095)	53.8 (12,095)	53.8 (12,095)
	9 (229)	200.9 (45,175)	208.5 (46,865)	208.5 (46,865)	71.7 (16,125)	71.7 (16,125)	71.7 (16,125)
	15 (381)	347.4 (78,110)	347.4 (78,110)	347.4 (78,110)	119.6 (26,880)	119.6 (26,880)	119.6 (26,880)
# 7 (22.2)	8 (203)	168.4 (37,860)	206.2 (46,365)	207.9 (46,740)	74.4 (16,725)	74.4 (16,725)	74.4 (16,725)
	10-1/2 (267)	253.2 (56,925)	272.9 (61,350)	272.9 (61,350)	97.6 (21,950)	97.6 (21,950)	97.6 (21,950)
	17-1/2 (445)	454.8 (102,250)	454.8 (102,250)	454.8 (102,250)	162.7 (36,585)	162.7 (36,585)	162.7 (36,585)
# 8 (25.4)	9 (229)	200.9 (45,175)	246.1 (55,325)	263.7 (59,290)	95.6 (21,505)	95.6 (21,505)	95.6 (21,505)
	13 (330)	348.8 (78,420)	380.9 (85,640)	380.9 (85,640)	138.2 (31,060)	138.2 (31,060)	138.2 (31,060)
	20 (508)	586.1 (131,755)	586.1 (131,755)	586.1 (131,755)	212.6 (47,785)	212.6 (47,785)	212.6 (47,785)
# 9 (28.6)	10-1/2 (267)	253.2 (56,925)	310.1 (69,720)	310.1 (69,720)	125.5 (28,220)	125.5 (28,220)	125.5 (28,220)
	13-1/2 (343)	369.2 (82,990)	437.3 (98,315)	437.3 (98,315)	161.4 (36,285)	161.4 (36,285)	161.4 (36,285)
	20 (508)	647.9 (145,650)	647.9 (145,650)	647.9 (145,650)	239.1 (53,755)	239.1 (53,755)	239.1 (53,755)
# 10 (32.2)	12 (305)	309.4 (69,550)	378.9 (85,180)	422.1 (94,895)	164.3 (36,940)	164.3 (36,940)	164.3 (36,940)
	15 (381)	432.4 (97,200)	527.6 (118,615)	527.6 (118,615)	205.4 (46,175)	205.4 (46,175)	205.4 (46,175)
	25 (635)	879.4 (197,695)	879.4 (197,695)	879.4 (197,695)	342.3 (76,960)	342.3 (76,960)	342.3 (76,960)

1 These load values are for the purposes of estimation only and should not be used in design
 2 Assuming single anchor with no edge or spacing distances, no environmental factors that would reduce the load.
 3 Design loads include their respective ϕ_c and ϕ_s material resistance factors for concrete and steel from CSA A23.3-14 Cl. 8.4.2 and 8.4.3
 4 Design loads include their respective strength reduction factor for dry, water saturated and water filled hole conditions. Refer to design information table for threaded rod for submerged conditions (ϕ_{sub}).

5 All design loads are calculated according to Condition B for concrete failure mode factor R
 6 Temperature Range A (long term temperature 43°C, short term temperature 55°C)
 7 Temperature Range B (long term temperature 43°C, short term temperature 80°C)
 8 Values for continuous inspection with dry, water saturated or water filled concrete

PERFORMANCE TABLES

A7+ Hybrid Adhesive

Recommended Edge Distance Requirements for Shear Loads Installed in Solid Concrete

ANCHOR DIAMETER In. (mm)		EMBEDMENT DEPTH In. (mm)		CRITICAL EDGE DISTANCE In. (mm) (100% LOAD CAPACITY)		INTERPOLATED EDGE DISTANCE In. (mm) (80% LOAD CAPACITY)		INTERPOLATED EDGE DISTANCE In. (mm) (50% LOAD CAPACITY)		MINIMUM EDGE DISTANCE In. (mm) (10% LOAD CAPACITY)	
3/8	(9.5)	3-3/8	(85.7)	4-3/16	(106.4)	3-7/16	(87.3)	2-5/16	(58.7)	13/16	(20.6)
1/2	(12.7)	4-1/2	(114.3)	5-5/8	(142.9)	4-5/8	(117.5)	3-1/8	(79.4)	1-1/8	(28.6)
5/8	(15.9)	5-5/8	(142.9)	7	(177.8)	5-3/4	(146.1)	3-1/8	(79.4)	1-3/8	(34.9)
3/4	(19.1)	6-3/4	(171.5)	8-7/16	(214.2)	6-15/16	(176.2)	4-5/8	(117.5)	1-5/8	(41.3)
1	(25.4)	9	(228.6)	11-1/4	(285.8)	9-1/4	(235.0)	6-1/4	(158.8)	2-1/4	(57.2)
1-1/4	(31.8)	11-1/4	(285.8)	14-1/16	(357.2)	11-5/8	(295.3)	7-7/8	(200.0)	2-7/8	(73.0)

A7+ Hybrid Adhesive

Recommended Edge Distance Requirements for Tension Loads Installed in Solid Concrete

ANCHOR DIAMETER In. (mm)		EMBEDMENT DEPTH In. (mm)		CRITICAL EDGE DISTANCE In. (mm) (100% LOAD CAPACITY)		INTERPOLATED EDGE DISTANCE In. (mm) (90% LOAD CAPACITY)		INTERPOLATED EDGE DISTANCE In. (mm) (80% LOAD CAPACITY)		MINIMUM EDGE DISTANCE In. (mm) (70% LOAD CAPACITY)	
3/8	(9.5)	3-3/8	(85.7)	2-1/2	(63.5)	1-15/16	(49.2)	1-3/8	(34.9)	13/16	(26.2)
		4-1/2	(114.3)	3-3/8	(85.7)	2-5/8	(66.7)	1-7/8	(47.6)	1-1/8	(28.6)
1/2	(12.7)	4-1/2	(114.3)	3-3/8	(85.7)	2-5/8	(66.7)	1-7/8	(47.6)	1-1/8	(28.6)
		6	(152.4)	4-1/2	(114.3)	3-1/2	(88.9)	2-1/2	(63.5)	1-1/2	(38.1)
5/8	(15.9)	5-5/8	(142.9)	4-3/16	(106.4)	3-1/4	(82.6)	2-5/16	(58.7)	1-3/8	(34.9)
		7-1/2	(190.5)	5-5/8	(142.9)	4-3/8	(111.1)	3-1/8	(79.4)	1-7/8	(47.6)
3/4	(19.1)	6-3/4	(171.5)	5-1/16	(128.6)	3-15/16	(100.0)	2-13/16	(71.4)	1-5/8	(15.9)
		9	(228.6)	6-3/4	(171.5)	5-1/4	(133.4)	3-3/4	(95.3)	2-1/4	(57.2)
1	(25.4)	9	(228.6)	6-3/4	(171.5)	5-1/4	(133.4)	3-3/4	(95.3)	2-1/4	(57.2)
		12	(304.8)	9	(228.6)	7	(177.8)	5	(127.0)	3	(76.2)
1-1/4	(31.8)	11-1/4	(285.8)	8-7/16	(214.3)	6-9/16	(166.7)	4-3/4	(120.7)	2-7/8	(73.0)
		15	(381.0)	11-1/4	(285.8)	8-3/4	(222.2)	6-1/4	158.8)	3-3/4	(95.3)

PERFORMANCE TABLES

A7+ Hybrid Adhesive

Grout-filled Concrete Block: Allowable Tension and Shear Loads based on Steel Design Information for U.S. Customary Unit Threaded Rod ^{1, 2, 3}

Anchor Diameter (in.)	Tension (lb)			Shear (lb)		
	ASTM A307 F _u = 60 ksi	ASTM A193 Grade B7 F _u = 125 ksi	ASTM F593 SS 304 F _u = 100 ksi	ASTM A307 F _u = 60 ksi	ASTM A193 Grade B7 F _u = 125 ksi	ASTM F593 SS 304 F _u = 100 ksi
3/8	2,185	4,555	3,645	1,125	2,345	1,875
1/2	3,885	8,100	6,480	2,000	4,170	3,335
5/8	6,075	12,655	10,125	3,130	6,520	5,215
3/4	8,750	18,225	12,390	4,505	9,390	6,385

For SI: 1 inch = 25.4mm, 1 lbf = 4.45N, 1ft-lbf = 1.356 N-M, 1 psi = 0.006895 MPa

1 Allowable load used in the design must be the lesser of bond values and tabulated steel element values.

2 Allowable tension and shear loads for threaded rods to resist short term loads, such as wind or seismic, must be calculated in accordance with Section 4.1 as applicable.

3 Allowable steel loads are based on allowable tension and shear stresses equal to 0.33X Fu and 0.17XFu, respectively.

A7+ Hybrid Adhesive

Grout-filled Concrete Block: Allowable Tension Loads for Threaded Rod ^{1, 2, 3, 4, 7, 9, 10, 11, 12}

Anchor Diameter (in.)	Minimum Embedment (inches)	Load at s _{cr} and c _{cr} (lb)	Spacing ⁵			Edge Distance ⁶		
			Critical s _{cr} (inches)	Minimum s _{min} (inches)	Load reduction factor for s _{min} ⁸	Critical c _{cr} (inches)	Minimum c _{min} (inches)	Load reduction factor for c _{min} ⁸
3/8	3-3/8	1,125	13.5	4	1.00	12	4	1.00
1/2	4-1/2	1,695	18	4	0.60	20	4	0.90
5/8	5-5/8	2,015	22.5	4	0.60	20	4	0.90
3/4	6-3/4	3,145	27	4	0.60	20	4	0.63

A7+ Hybrid Adhesive

Grout-filled Concrete Block: Allowable Shear Loads for Threaded Rod ^{1, 2, 3, 4, 7, 9, 10, 11, 12}

Anchor Diameter (in.)	Minimum Embedment (inches)	Load at s _{cr} and c _{cr} (lb)	Spacing ⁵			Edge Distance ⁶		
			Critical s _{cr} (inches)	Minimum s _{min} (inches)	Load reduction factor for s _{min} ⁸	Critical c _{cr} (inches)	Minimum c _{min} (inches)	Load reduction factor for c _{min} ⁸
3/8	3-3/8	750	13.5	4	0.50	12	4	0.95
1/2	4-1/2	1,520	18	4	0.50	20	4	.044
5/8	5-5/8	2,285	22.5	4	0.50	22	4	0.26
3/4	6-3/4	2,345	27	4	0.50	20	4	0.26

For SI: 1 inch = 25.4mm, 1 lbf = 0.0044 kN, 1 ksi = 6.894 MPa. (Refer to Table 4 for footnotes)

- All values are for anchors installed in fully grouted concrete masonry with minimum masonry strength of 1500 psi (10.3 MPa). Concrete masonry units must be light-, medium-, or normal-weight conforming to ASTM C 90. Allowable loads have been calculated using a safety factor of 5.0.
- Anchors may be installed in any location in the face of the masonry wall (cell, web, bed joint) as shown in Figure 2.
- A maximum of two anchors may be installed in a single masonry cell in accordance with the spacing and edge or end distance requirements. Embedment is measured from the outside surface of the concrete masonry unit to the embedded end of the anchor. See Figure 2 of this report.
- The critical spacing distance, s_{cr}, is the anchor spacing where full load values in the table may be used. The minimum spacing distance, s_{min}, is the minimum anchor spacing for which values are available and installation is permitted. Spacing distance is measured from the centerline to centerline between two anchors.
- The critical edge or end distance, c_{cr}, is the distance where full load values in the table may be used. The minimum edge or end distance, c_{min}, is the minimum distance for which values are available and installation is permitted. Edge or end distance is measured from anchor centerline to the closest unrestrained edge.
- The tabulated values are applicable for anchors in the ends of grout-filled concrete masonry units where minimum edge distances are maintained.
- Load values for anchors installed less than s_{cr} and c_{cr} must be multiplied by the appropriate load reduction factor based on actual spacing (s) or edge distance (c). Load factors are multiplicative; both spacing and edge reduction factors must be considered.
- Linear interpolation of load values between minimum spacing (s_{min}) and critical spacing (s_{cr}) and between minimum edge or end distance (c_{min}) and critical edge or end distance (c_{cr}) is permitted.
- Concrete masonry width (wall thickness) must be equal to or greater than 1.5 times the anchor embedment depth (e.g. 3/8-inch- and 1/2-inch-diameter anchors are permitted in minimum nominally 6-inch-thick concrete masonry). The 5/8- and 3/4-inch-diameter anchors must be installed in minimum nominally 8-inch-thick concrete masonry.
- Allowable loads must be the lesser of the adjusted masonry or bond values tabulated above and the steel strength values given in Table 2.
- Tabulated allowable bond loads must be adjusted for increased in-service base material temperatures in accordance with Figure 1, as applicable.

PERFORMANCE TABLES

A7+ Hybrid Adhesive

Grout-filled Concrete Block: Allowable Tension and Shear Loads for Rebar^{1, 2, 3}

Rebar Size	Tension (lb)	Shear (lb)
	ASTM A615, Grade 60	ASTM A615, Grade 60
No. 3	3,270	1,685
No. 4	5,940	3,060
No. 5	9,205	4,745
No. 6	13,070	6,730

For SI: 1 inch = 25.4mm, 1 lbf = 4.45N, 1ft-lbf = 1.356 N-M, 1 psi = 0.006895 MPa

1 Allowable load used in the design must be the lesser of bond values and tabulated steel element values.

2 Allowable tension and shear loads for threaded rods to resist short term loads, such as wind or seismic, must be calculated in accordance with Section 4.1 as applicable.

3 Allowable steel loads are based on allowable tension and shear stresses equal to 0.33X Fu and 0.17X Fu, respectively.

A7+ Hybrid Adhesive

Grout-filled Concrete Block: Allowable Tension Loads for Rebar^{1, 2, 3, 4, 7, 9, 10, 11, 12}

Anchor Diameter (in.)	Minimum Embedment (inches)	Load at s_{cr} and c_{cr} (lb)	Spacing ⁵			Edge Distance ⁶		
			Critical s_{cr} (inches)	Minimum s_{min} (inches)	Load reduction factor for s_{min} ⁸	Critical c_{cr} (inches)	Minimum c_{min} (inches)	Load reduction factor for c_{min} ⁸
3/8	3-3/8	1,530	13.5	4	1.00	12	4	1.00
1/2	4-1/2	1,845	18	4	0.60	20	4	0.90
5/8	5-5/8	2,465	22.5	4	0.60	20	4	0.90
3/4	6-3/4	2,380	27	4	0.60	20	4	0.63

A7+ Hybrid Adhesive

Grout-filled Concrete Block: Allowable Shear Loads for Rebar^{1, 2, 3, 4, 7, 9, 10, 11, 12}

Anchor Diameter (in.)	Minimum Embedment (inches)	Load at s_{cr} and c_{cr} (lb)	Spacing ⁵			Edge Distance ⁶		
			Critical s_{cr} (inches)	Minimum s_{min} (inches)	Load reduction factor for s_{min} ⁸	Critical c_{cr} (inches)	Minimum c_{min} (inches)	Load reduction factor for c_{min} ⁸
3/8	3-3/8	1,410	13.5	4	0.50	12	4	0.95
1/2	4-1/2	1,680	18	4	0.50	20	4	0.44
5/8	5-5/8	3,245	22.5	4	0.50	12	4	0.26
3/4	6-3/4	4,000	27	4	0.50	20	4	0.26

For SI: 1 inch = 25.4 mm; 1 lbf = 0.0044 kN, 1 ksi = 6.894 MPa.

(The following footnotes apply to both Tables 6 and 7)

1 All values are for anchors installed in fully grouted concrete masonry with minimum masonry strength of 1500 psi (10.3 MPa). Concrete masonry units must be light-, medium, or normal-weight conforming to ASTM C 90. Allowable loads have been calculated using a safety factor of 5.0.

3 Anchors may be installed in any location in the face of the masonry wall (cell, web, bed joint) as shown in figure 2.

4 A maximum of two anchors may be installed in a single masonry cell in accordance with the spacing and edge or end distance requirements. Embedment is measured from the outside surface of the concrete masonry unit to the embedded end of the anchor. See Figure 2 of this report.

5 The critical spacing distance, s_{cr} , is the anchor spacing where full load values in the table may be used. The minimum spacing distance, s_{min} , is the minimum anchor spacing for which values are available and installation is permitted. Spacing distance is measured from the centerline to centerline between two anchors.

6 The critical edge or end distance, c_{cr} , is the distance where full load values in the table may be used. The minimum edge or end distance, c_{min} , is the minimum distance for which values are available and installation is permitted. Edge or end distance is measured from anchor centerline to the closest unrestrained edge.

7 The tabulated values are applicable for anchors in the ends of grout-filled concrete masonry units where minimum edge distances are maintained.

8 Load values for anchors installed less than s_{cr} and c_{cr} must be multiplied by the appropriate load reduction factor based on actual spacing (s) or edge distance (c). Load factors are multiplicative; both spacing and edge reduction factors must be considered.

9 Linear interpolation of load values between minimum spacing (s_{min}) and critical spacing (s_{cr}) and between minimum edge or end distance (c_{min}) and critical edge or end distance (c_{cr}) is permitted.

10 Concrete masonry width (wall thickness) must be equal to or greater than 1.5 times the anchor embedment depth (e.g. No. 3 and No. 4 reinforcing bars are permitted in minimum nominally 6-inch-thick concrete masonry). No. 5 and No. 6 reinforcing bars must be installed in minimum nominally 8-inch-thick concrete masonry.

11 Allowable loads must be the lesser of the adjusted masonry or bond values tabulated above and the steel strength values given in Table 4.

12 Tabulated allowable bond loads must be adjusted for increased in-service base material temperatures in accordance with Figure 1, as applicable.

Umbrella Inserts and Stubby Screens

High Performance Adhesive Systems for Fastening to Hollow Base Materials



A7P-10



9200

DESCRIPTION/ADVANTAGES

Hollow Block Fastening with A7+ Adhesive

9200

Umbrella Inserts—specially designed for fastening to the face of hollow concrete block, brick, clay tile or terra cotta. Accepts 3/8" rods

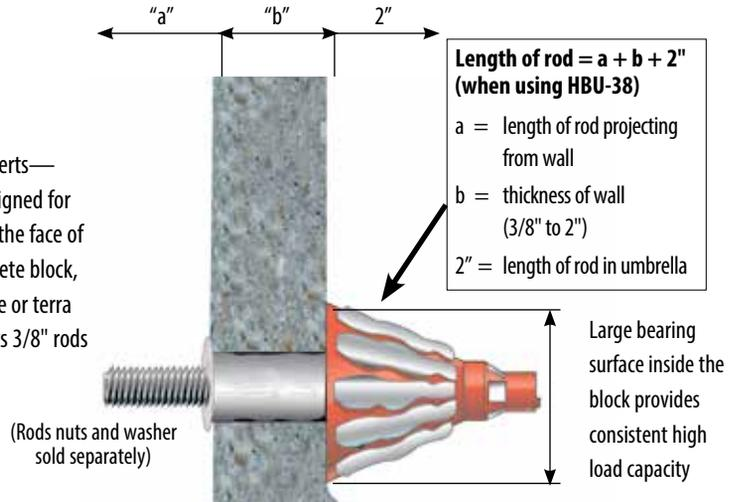

STUBBY SCREENS

Specially designed stainless steel screens provide maximum performance for a screen in the front face of hollow concrete block. Screens available for rods 1/4" to 5/8"

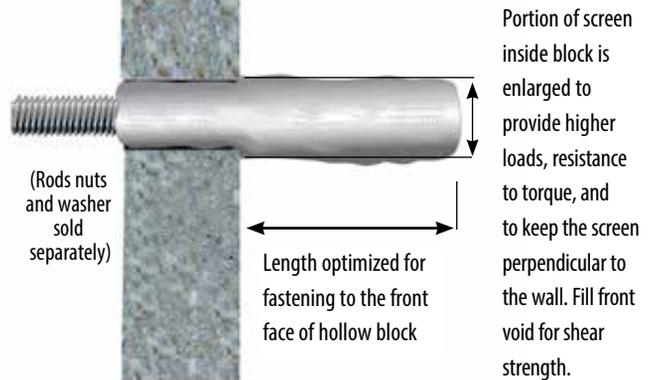

Section View—Concrete Block

Umbrella Inserts and Screens

INSTALLATION STEPS

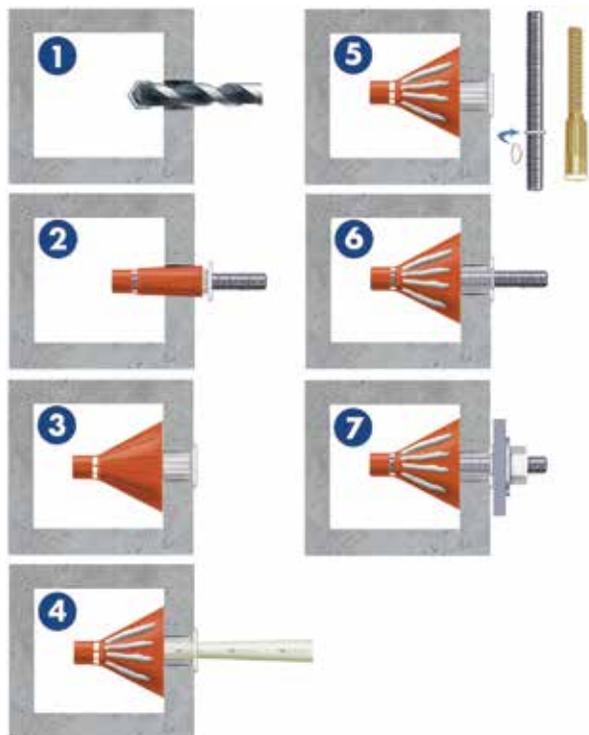

1. Drill 3/4" diameter hole, 3-3/4" deep using rotation only drilling mode and carbide tipped drill bit. Clean out hole with forced air. Complete hole preparation with use of a brush and repeat cleaning with compressed air (leave no dust or slurry).
2. Place umbrella on piece of threaded rod, stretch umbrella over the rod by pulling the white collar back approximately 1". Squeeze orange portion of umbrella and push umbrella into hole.
3. Push umbrella body through the hole and completely into void. Remove threaded rod. (Do not use in solid base materials. For anchoring into block web, ends and mortar joints, use screens.) View and verify umbrella wings expanded behind wall.
4. Dispense and discard a sufficient amount of adhesive from new cartridge until a uniform adhesive mix is achieved. Inject approximately 1-1/2 fl. oz. of adhesive into umbrella (7 to 8 pumps using manual dispenser) to completely fill umbrella.
5. 3/8" rod uses a centering ring (supplied with inserts) to keep rod perpendicular to the wall.
6. Insert rod into the filled umbrella using a slow, soft twisting motion until it contacts the back of umbrella.
7. Wait for appropriate temperature/cure time before tightening fixture to the recommended torque of 10 ft./lbs.

Installation instructions for stubby screens provided on page RH 32.

SELECTION CHART

Umbrella Inserts



DESCRIPTION	PART NO.	BOX CONTENTS
Umbrella Anchor 	9200	20 Umbrellas 20 Centering Rings

SELECTION CHART

Stubby Screens



PART NO.	DESCRIPTION	QTY/BOX
HB 38-312	3/8" x 3-1/2" Stainless Screen	100
HB 12-312	1/2" x 3-1/2" Stainless Screen	50
HB 58-412	5/8" x 4-1/2" Stainless Screen	50

ESTIMATING TABLE

Umbrella Inserts

**Number of Anchoring Installations Per Cartridge*
Using Threaded Rod and Umbrella Inserts with A7+
Adhesives in Hollow Base Material**

ROD In (mm)	DRILL HOLE DIA. INCHES	VOLUME OF CARTRIDGE	UMBRELLA INSERT WITH EMBEDMENT OF 3-3/4"
3/8 (9.5)	3/4	A7+ 10 fluid oz.	6
		A7+ 28 fluid oz.	17

* These estimates do not account for waste.

ESTIMATING TABLE

Stubby Screens

Number of Anchoring Installations Per Cartridge* Using Threaded Rod and Stubby Screens with A7+ Adhesives in Hollow Base Material

ROD In (mm)	DRILL HOLE DIA. INCHES	VOLUME OF CARTRIDGE	SCREEN LENGTH PLUS 1 DIAMETER (INCHES)		
			2"	3-1/2"	4-1/2"
3/8 (9.5)	1/2	A7+ 10 fluid oz.		21	
		A7+ 28 fluid oz.		62	
1/2 (12.7)	5/8	A7+ 10 fluid oz.		15	
		A7+ 28 fluid oz.		43	
5/8 (15.9)	3/4	A7+ 10 fluid oz.			11
		A7+ 28 fluid oz.			24

* These estimates do not account for waste.

PERFORMANCE TABLE

Load Values^{1, 2}

Using A7+ in Hollow Concrete Block

	ROD DIA. In. (mm)	MAX CLAMPING FORCE AFTER PROPER CURE Ft.-Lbs. (Nm)	DRILL HOLE DIA. In. (mm)	EMBEDMENT (SCREEN LENGTH) In. (mm)	ULTIMATE TENSION Lbs. (Kn)	ULTIMATE SHEAR Lbs. (Kn)
Umbrella	3/8 (9.5)	10 (13)	3/4 (19.1)	3-3/4 (95.3)	3,558 (15.8)	3,109 (13.8)
Stubby Screens	3/8 (9.5)	7 (9)	1/2 (12.7)	3-7/8 (98.4)	1,661 (7.4)	2,071 (9.2)
	1/2 (12.7)	10 (13)	5/8 (15.9)	4 (101.6)	2,458 (10.9)	4,467 (19.9)
	5/8 (15.9)	13 (17)	3/4 (19.1)	5-1/8 (130.2)	2,543 (10.9)	5,047 (22.4)

¹ Allowable working loads should not exceed 25% ultimate capacity. Based upon testing using ASTM A193, Grade B7 rod.

² The tabulated values are for anchors installed at a minimum 12 inch edge distance and minimum 8 inch spacing.

Screen Tubes

Quality Adhesive Systems for Fastening Through Block and for Brick Pinning Applications



A7P-10

Nylon Screens



DESCRIPTION/SUGGESTED SPECIFICATIONS

Screens Used with A7+

HOLLOW CONCRETE BLOCK

Maximum holding strength in concrete block can be obtained by fastening to both the front and back of the block using an adhesive screen tube and threaded rod.

For attachments to single face of block, see page RH 29 for information on "umbrella anchors" and "stubby screens"

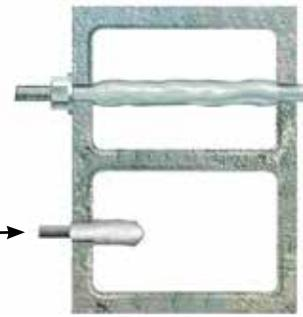

Top View

BRICK WALL

Systems designed for Seismic Retrofit, Brick Pinning or fastening to brick— various lengths and diameters available to accommodate site conditions.

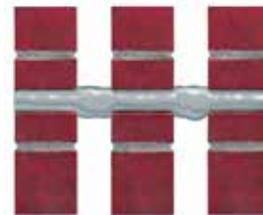

Section

The no-drip feature of A7+ adhesive makes it particularly well suited for brick pinning applications.

ADVANTAGES

HBP SERIES—NYLON SCREENS

- 30%-50% savings from stainless steel screens
- Comparable performance values
- Easier to insert and span across voids
- Flexible material is less susceptible to damage from crushing

INSTALLATION STEPS



1. Drill hole to the length of the screen plus 1 diameter, using rotation-only drilling mode. Clean out hole with forced air. Complete hole preparation with use of a brush and repeat cleaning with forced air (leave no dust or slurry).



2. When starting new cartridge or new nozzle, dispense and discard enough adhesive until uniform adhesive mix is achieved. Insert the nozzle into the bottom of the screen and **fill screen completely full** (use extension tube if needed to reach bottom of screen).



3. Insert the filled screen completely into the hole (subflush).

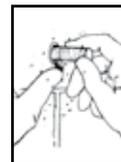

4. While holding the tab of the screen against the wall, hand insert the selected rod slowly into the screen tube with a slow twisting motion. Pull screen flush to face and coat with adhesive. Wait for appropriate cure time before torquing fixture in place.

ESTIMATING TABLE

Screen Tubes

Number of Anchoring Installations Per Cartridge* Using Threaded Rod and Screen Tubes with A7+ Adhesives in Hollow Base Material

ROD In (mm)	DRILL HOLE DIA. INCHES	VOLUME OF CARTRIDGE	SCREEN LENGTH (INCHES)			
			6"	8"	10"	13"
3/8 (9.5)	1/2	A7+ 10 fluid oz.	12	10	7.5	
		A7+ 28 fluid oz.	37	29	23	
1/2 (12.7)	5/8	A7+ 10 fluid oz.	9	6	5	
		A7+ 28 fluid oz.	26	18	14	
5/8 (15.9)	3/4	A7+ 10 fluid oz.	6	5	4	
		A7+ 28 fluid oz.	18	14	10	
3/4 (19.1)	7/8	A7+ 10 fluid oz.			2.5	1.75
		A7+ 28 fluid oz.			6	5

* These estimates do not account for waste.

SELECTION CHART

Screen Tubes



HBP Nylon Screen

ROD DIA. In. (mm)	SCREEN LENGTH In. (mm)	NYLON SCREENS		
		PART NO.	QTY/BOX	QTY/MASTER
3/8 (9.5)	6 (152.4)	HBP 38-6	50	100
3/8 (9.5)	10 (254.0)	HBP 38-10	25	50
1/2 (12.7)	6 (152.4)	HBP 12-6	50	100
1/2 (12.7)	10 (254.0)	HBP 12-10	25	50
5/8 (15.9)	6 (152.4)	HBP 58-6	40	---
5/8 (15.9)	10 (254.0)	HBP 58-10	40	---
3/4 (19.1)	8 (203.2)	*	*	*
3/4 (19.1)	10 (254.0)	HBP 34-10	20	---

* Not available in standard strength nylon screens. Longer screens available through specials.

PERFORMANCE TABLE

Load Values

Average Ultimate Loads for HBP (nylon) Screens Used with A7+ in Hollow Concrete Block¹



ROD DIA. In. (mm)	DRILL HOLE DIA. In. (mm)	MAX CLAMPING FORCE AFTER PROPER CURE Ft.-Lbs. (Nm)	SCREEN EMBEDMENT (LENGTH) In. (mm)	ULTIMATE TENSION Lbs. (kN)	ULTIMATE SHEAR Lbs. (kN)
1/4 (6.4)	3/8 (9.5)	5 (6)	8 (203.2)	2,072 (9.2)	2,264 (10.1)
3/8 (9.5)	1/2 (12.7)	12 (16)	8 (203.2)	2,360 (10.5)	2,668 (11.9)
1/2 (12.7)	5/8 (15.9)	19 (25)	8 (203.2)	2,647 (11.8)	2,668 (11.9)
5/8 (15.9)	3/4 (19.1)	26 (35)	8 (203.2)	2,647 (11.8)	3,578 (15.9)
3/4 (19.1)	7/8 (22.2)	28 (37)	8 (203.2)	2,647 (11.8)	4,573 (20.3)

¹ Allowable working loads should not exceed 25% of ultimate capacity. Loads based upon testing with ASTM A193, Grade B7 rods.

Accessories



Wire Brush Extensions

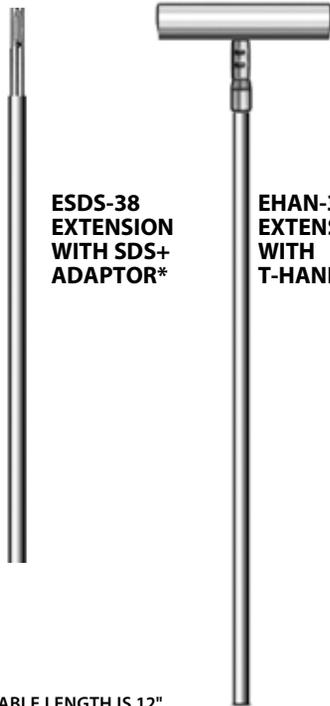

**ESDS-38
EXTENSION
WITH SDS+
ADAPTOR***

**EHAN-38
EXTENSION
WITH
T-HANDLE***

* USABLE LENGTH IS 12",
GOOD FOR ALL HOLES EXCEPT 7/16" DIAMETER

DESCRIPTION/ADVANTAGES

Piston Plugs



DESCRIPTION	PART #	QTY/BAG
Piston Plug for 5/8" and 3/4" diameter anchors	PL-5834	10
Piston Plug for 7/8" and 1" diameter anchors	PL-7810	10
Piston Plug for 1-1/4" diameter anchors	PL-1250	10

Wire Brushes

Proper hole cleaning using a brush is essential to achieve optimum performance



1/8" NPT
(National Pipe
Thread Taper)

PART #	ANCHOR DIA.	REBAR	DRILL BIT DIA.	BRUSH DIA.	QTY/BAG
WB-038	3/8"	No. 3	7/16"	5/8"	10
WB-012	1/2"	No. 4	5/8"	3/4"	10
WB-058	5/8"	No. 5	3/4"	1"	10
WB-034	3/4"	No. 6	7/8"	1-1/4"	10
WB-078	7/8"	—	1"	1-1/2"	10
WB-100	1"	No. 8	1-1/8"	1-5/8"	10
WB-125	1-1/4"	—	1-3/8"	1-3/4"	10
B012	1/2" Diameter Nylon Brush (Soft enough for Masonry)				1
ESDS-38	Wire brush 12" usable extension with SDS+ adaptor				1
EHAN-38	Wire brush 12" usable extension with T-Handle				1

* Proper hole cleaning using a wire brush is essential to achieve optimum performance.
Brush may be used up to 50 holes depending on concrete strength.
Brushes required for installation of No. 4, No. 8 rebar and larger are available with lead time.

Plastic Extension Tubing



DESCRIPTION	PART #	QTY/BAG
6-Foot Straight Tubing Can cut to proper size (.39 in. I.D. x .43 in. O.D.)	E25-6	5
Heavy Duty 6' Extension Tube (Fits Piston Plugs)	E916-6	5

Blow Pump



DESCRIPTION	PART #	QTY/BAG
Blow Pump	065990	1



Since 1910, the brand trusted by the construction industry for quality, innovation and engineering support

The RED HEAD product line has long been respected by both contractors and specifiers in the construction industry. Because ITW RED HEAD proactively gets RED HEAD products specified before the job starts, contractors save time and money, plus the hassle of getting products approved. We will continue to pursue code approvals for specific anchor usages.

RED HEAD has also been on the forefront of concrete anchoring industry innovation and development.

For example, we

- | developed the first anchor (the Self-Drill in 1910)
- | developed the full threaded Trubolt® Wedge anchor with a stainless steel clip
- | developed the lipped Multi-Set II® Drop-In anchor
- | helped develop (as part of ITW) markets for the Tapcon® and E-Z Ancor™

RED HEAD is committed to providing contractors with quality products and developing new products to meet the demand of contractors worldwide.



Selection Guide

ANCHOR TYPE

KEY FEATURES

SIZE RANGE (Inches)



Trubolt[®] Wedge Anchors

(see page RH 40)



- Seismic zone (A-B) approved
- Fully-threaded
- Length ID head stamped
- Through-fixture fastening

Diameter: 1/4 – 3/4

Length: 2-1/4 – 7



Large Diameter Tapcon (LDT) Self-Threading Anchor

(see page RH 42)



- 2x faster installation than wedge anchor
- Anti-rotation serrated washer
- Extra large hex washer head
- Length ID head stamped
- Through-fixture fastening

Diameter: 3/8 and 5/8

Length: 1-3/4 – 6

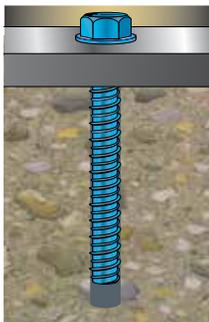

Tapcon+[®] Self-Threading Anchors with Climaseal Coating

(see page RH 47)



- 2x faster installation than wedge anchor
- Anti-rotation serrated washer
- Extra large hex washer head
- Length ID head stamped
- Through-fixture fastening
- Climaseal coating for high corrosion-resistance
- Approved for cracked, uncracked, and seismic applications
- 20% more holding power than wedge or sleeve anchors

Diameter: 1/4, 3/8, 1/2

Length: 2-1/4 – 6

	CORROSION RESISTANCE	PERFORMANCE	HEAD STYLES	APPROVALS/LISTINGS
Trubolt cont'd	<ul style="list-style-type: none"> Zinc-Plated Carbon Steel 	Ultimate Pullout Performance in 4000 psi Concrete up to 26,540 lbs. (1" diameter)	Hex nut Tie-Wire version	Underwriters Laboratories Factory Mutual Listed for use in seismic zones A & B
LDT cont'd	<ul style="list-style-type: none"> Zinc-plated carbon steel to ASTM B695 & B633 	Ultimate Pullout Performance in 4,000 psi Concrete up to 23,266 lbs. (3/4" diameter)	Finished bolt style	Miami-Dade County – #04-1025.08 Florida Building Code
Tapcon+® cont'd	<ul style="list-style-type: none"> Blue Climaseal Coating Approved for use in ACQ and MCQ lumber 	Factored Pullout Performance in 4000 PSI Concrete up to 6,720 LBF (1/2" Diameter)	Finished bolt style	ICC ESR-3699 – Cracked & Uncracked and Seismic approved City of Los Angeles (1/4" & 3/8" diameters) Florida Building Code Compliant 720 hours salt* spray ASTM B117

continued on next page

Anchors for Concrete Applications

continued from pages RH 36-37

ANCHOR TYPE	KEY FEATURES	SIZE RANGE (Inches)
 <p>Multi-Set II® Drop-In Anchors</p>  <p>RM RL RX</p> <p>(see page RH 52)</p>	<ul style="list-style-type: none"> ■ RM: Flanged body to keep anchor flush with surface of concrete ■ RL: Non-flanged body for recessed setting ■ RX: Designed for hollow core and post tension concrete 	<p>Diameter: 1/4 – 3/4 Length: 1 – 3-3/16</p> <hr/> <p>Diameter: 1/4 – 3/4 Length: 1 – 3-3/16</p> <hr/> <p>Diameter: 3/8 & 1/2 Length: 3/4</p>
 <p>Dynabolt® Masonry Sleeve Anchors</p>  <p>For both Hollow and Solid Concrete Applications</p> <p>(see page RH 56)</p>	<ul style="list-style-type: none"> ■ Concrete, block and brick ■ Many choices of head styles ■ Through-fixture fastening ■ Available in 304 stainless steel 	<p>Diameter: 1/4 – 3/4 Length: 1-3/8 – 6-1/4</p>
<p>Hammer-Set™ Nail-drive Anchors</p>  <p>(see page RH 59)</p>	<ul style="list-style-type: none"> ■ Easy installation ■ Low profile head ■ Through-fixture fastening 	<p>Diameter: 3/16 & 1/4 Length: 7/8 – 2</p>

CORROSION RESISTANCE	PERFORMANCE	HEAD STYLES	APPROVALS/LISTINGS
<b style="color: red;">Multi-Set II Drop-In <small>cont'd</small> <ul style="list-style-type: none"> ■ Zinc-plated carbon steel to ASTM B633, SC1, Type III ■ Type 18-8 and 316 stainless steel 	Ultimate Pullout Performance in 4000 psi Concrete up to 9,480 lbs. (3/4" diameter)	RM: Flanged body RL: Non-flanged body Use any bolt or threaded rod	GSA: A-A-55614 Type 1 (Formerly GSA: FF-S-325 Group VIII) Underwriters Laboratories Factory Mutual City of Los Angeles – #RR2748 California State Fire Marshal Caltrans
<b style="color: red;">Dynabolt <small>cont'd</small> <ul style="list-style-type: none"> ■ Zinc-plated carbon steel to ASTM B633, SC1, Type III ■ Type 304 stainless steel 	Ultimate Pullout Performance in 4000 psi Concrete up to 8,900 lbs. (3/4" diameter)	Flat head Hex nut Tie-Wire	GSA: A-A-1922A (Formerly GSA: FF-S-325 Group II, Type 3, Class 3) Factory Mutual California State Fire Marshal
<b style="color: red;">Hammer-Set <small>cont'd</small> <ul style="list-style-type: none"> ■ Zinc alloy 	Ultimate Pullout Performance in 4000 psi Concrete up to 793 lbs.	Mushroom head	GSA: A-A-1925A Type 1 (zinc mushroom) (Formerly GSA: FF-S-325 Group V, Type 2, Class 3)

Because applications vary, ITW RED HEAD cannot guarantee the performance of this product. Each customer assumes all responsibility and risk for the use of this product. The safe handling and the suitability of this product for use is the sole responsibility of the customer. Specific job site conditions should be considered when selecting the proper product. Should you have any questions, please call the Technical Assistance Department at 800-899-7890.

Trubolt[®] Stainless Steel Wedge Anchors

*Dependable,
Inspectable,
Wedge Type
Expansion Anchor*



Trubolt[®]
Wedge Anchors

APPROVALS/LISTINGS

Underwriters Laboratories
Factory Mutual
Listed for use in seismic zones A & B

DESCRIPTION/SUGGESTED SPECIFICATIONS

Wedge Type Anchors—

SPECIFIED FOR ANCHORAGE INTO CONCRETE

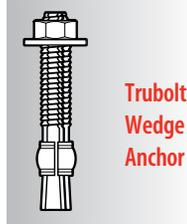

Trubolt Wedge Stainless Steel anchors feature an expansion clip, threaded stud body, nut and washer. Anchor bodies are made of type 304 stainless steel as identified in the drawings or other notations. The exposed end of the anchor is stamped to identify anchor length. Stampings should be preserved during installation for any subsequent embedment verification.

APPLICATIONS

Designed for both, indoor and outdoor applications



Anchoring machinery and conveyors is a common wedge anchor application. The Trubolt is fully threaded to allow a large range of embedment and fixture thickness.



Stainless steel Trubolt wedge anchors provide higher corrosion resistance allowing anchoring in tougher environments.



LENGTH INDICATOR CODE*

CODE	LENGTH OF ANCHOR	CODE	LENGTH OF ANCHOR
A	1-1/2 < 2 (38.1 < 50.8)	K	6-1/2 < 7 (165.1 < 177.8)
B	2 < 2-1/2 (50.8 < 63.5)	L	7 < 7-1/2 (177.8 < 190.5)
C	2-1/2 < 3 (63.5 < 76.2)	M	7-1/2 < 8 (190.5 < 203.2)
D	3 < 3-1/2 (76.2 < 88.9)	N	8 < 8-1/2 (203.2 < 215.9)
E	3-1/2 < 4 (88.9 < 101.6)	O	8-1/2 < 9 (215.9 < 228.6)
F	4 < 4-1/2 (101.6 < 114.3)	P	9 < 9-1/2 (228.6 < 241.3)
G	4-1/2 < 5 (114.3 < 127.0)	Q	9-1/2 < 10 (241.3 < 254.0)
H	5 < 5-1/2 (127.0 < 139.7)	R	10 < 11 (254.0 < 279.4)
I	5-1/2 < 6 (139.7 < 152.4)	S	11 < 12 (279.4 < 304.8)
J	6 < 6-1/2 (152.4 < 165.1)	T	12 < 13 (304.8 < 330.2)

* Located on top of anchor for easy inspection.

INSTALLATION STEPS

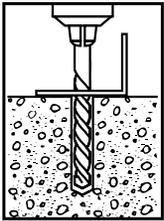

1.

Select a carbide drill bit with a diameter equal to the anchor diameter. Drill hole at least 1/4" deeper than normal anchor embedment.

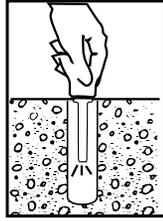

2.

Clean hole with pressurized air or vacuum to remove any excess dust/debris.



3.

Using the washer and nut provided, assemble the anchor, leaving nut one half turn from the end of the anchor to protect threads. Drive anchor through fixture to the specified embedment. Fasten nut and washer flush to surface of fixture.

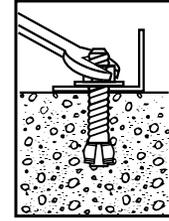

4.

Expand anchor by tightening nut 3-5 to the specified setting torque.

SELECTION CHARTS

Trubolt Type 304 Stainless Steel

Serves many applications well. It withstands rusting in architectural and food processing environments and resists organic chemicals, dye stuffs and many inorganic chemicals.



Typical Applications—
Cladding, Stadium Seating, etc.

Environment—Urban
(slight to moderate
degree of pollution)

Level of Corrosion—Medium

**Tie Wire Wedge for hanging
suspended ceiling**

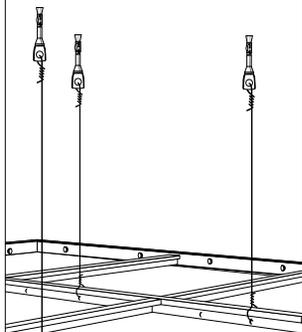

PART NUMBER	THREAD LENGTH In. (mm)	ANCHOR DIA. & DRILL BIT SIZE (THREADS) PER INCH	OVERALL LENGTH In. (mm)	MAX. THICKNESS OF MATERIAL TO BE FASTENED In. (mm)	QTY/WT PER BOX lbs.	QTY/WT PER MASTER CARTON lbs.
WW-1422	1-1/4 (31.8)	1/4" - 20	2-1/4 (57.2)	7/8 (22.2)	100/ 3.7	1000/ 37
WW-1432	2-1/4 (57.2)		3-1/4 (82.6)	1-7/8 (47.6)	100/ 4.8	800/ 39
WW-3822*+	1-1/8 (28.6)	3/8" - 16	2-1/4 (57.2)	3/8 (9.5)	50/ 4.1	500/ 41
WW-3826*+	1-5/8 (41.3)		2-3/4 (69.9)	7/8 (22.2)	50/ 4.8	400/ 39
WW-3830*+	1-3/4 (44.5)		3 (76.2)	1-1/8 (28.6)	50/ 5.1	400/ 42
WW-3836*+	2-1/2 (63.5)		3-3/4 (95.3)	1-7/8 (47.6)	50/ 6.0	300/ 37
WW-3850*+	3-3/4 (95.3)		5 (127.0)	3-1/8 (79.4)	50/ 7.5	250/ 39
WW-1236*+	2-1/4 (57.2)	1/2" - 13	3-3/4 (95.3)	1 (25.4)	25/ 5.8	150/ 36
WW-1242*+	2-3/4 (69.9)		4-1/4 (108.0)	1-1/2 (38.1)	25/ 6.3	150/ 39
WW-1254*+	3 (76.2)		5-1/2 (139.7)	2-3/4 (69.9)	25/ 7.7	150/ 47
WW-1270*+	3-1/2 (88.9)		7 (177.8)	4-1/4 (108.0)	25/ 9.4	150/ 57
WW-5850*+	3-1/4 (82.6)	5/8" - 11	5 (127.0)	1-5/8 (41.3)	10/ 4.8	100/ 49
WW-5860*+	4-1/4 (107.9)		6 (152.4)	2-5/8 (66.7)	10/ 5.5	50/ 28
WW-3446*+	2-7/8 (73.0)	3/4" - 10	4-3/4 (120.7)	3/4 (19.1)	10/ 6.7	60/ 41
WW-3454*+	3-5/8 (92.1)		5-1/2 (139.7)	1-1/2 (38.1)	10/ 7.5	50/ 38
WW-3470*+	3-1/2 (88.9)		7 (177.8)	3 (76.2)	10/ 9.2	30/ 28
TIE WIRE						
TW-1400	N/A	1/4"	2-1/8 (54.0)	9/32-hole (7.1)	100/ 3.6	1000/ 36

* FM Approved + UL Approved

For continuous extreme low temperature applications, use stainless steel.

INSTALLATION TABLE

TRUBOLT WEDGE ANCHOR (INSTALLED)

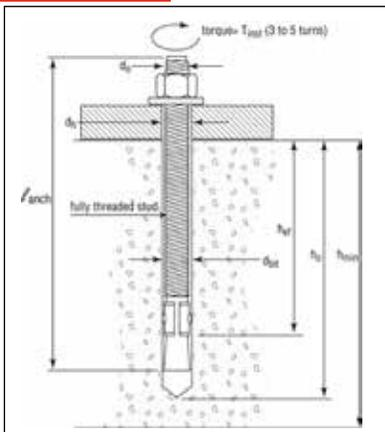

TRUBOLT WEDGE INSTALLATION INFORMATION

	Symbol	Units	Nominal Anchor Diameter (in.)									
			1/4"	3/8"	1/2"	5/8"	3/4"	1"	1-1/8"	1-1/4"	1-3/8"	1-1/2"
Anchor outer diameter	d_o	in	0.25	0.375	0.5	0.625	0.750	1.0	1.125	1.25	1.5	1.75
Nominal carbide bit diameter	d_{bit}	in	1/4	3/8	1/2	5/8	3/4	1	1-1/8	1-1/4	1-3/8	1-1/2
Effective embedment depth	h_{ef}	in	1-1/2	2	1-3/4	2-5/8	1-7/8	3-3/8	2-1/2	4	3-1/2	4-3/4
Min hole depth	h_o	in	2	2-1/2	2-1/2	3-3/8	2-3/4	4-1/4	3-3/4	5-1/4	4-3/4	6
Min slab thickness	h_{min}	in	4	4	5	5	6	5	8	6	8	8
Installation torque	T_{inst}	ft-lb	4	25	55	90	110	150	200	250	300	350
Min hole diameter in fixture	d_h	in	5/16	7/16	9/16	11/16	13/16	1/2	5/8	3/4	7/8	1

For performance data, please visit www.itwredhead.ca

Trubolt®
Wedge Anchors

Large Diameter Tapcon (LDT) Anchors

Finished Head, Removable Anchor



LDT
Sawtooth™

Uses standard drill bits—
no special drill bits to
purchase or lose!

DESCRIPTION/SUGGESTED SPECIFICATIONS

Self-threading Anchors—

SPECIFIED FOR ANCHORAGE INTO CONCRETE



LDT
Self-threading
Anchor

The LDT anchor is a high performance anchor that cuts its own threads into concrete.

Anchor bodies are made of hardened carbon steel and zinc plated.

The anchors shall have a finished hex washer head with anti-rotation serrations to prevent anchor back-out. The head of the anchor is stamped with a length identification code for easy inspection.

The anchor shall be installed with carbide tipped hammer drill bits made in accordance to ANSI B212.15-1994.

ADVANTAGES

SAVE TIME

EASILY INSTALLED

- Installs in less than half the time of wedge anchors or adhesive anchors
- Simply drill a pilot hole and drive the LDT anchor by hand or impact

EASILY REMOVED

- No torching or grinding required to remove anchors

SAVE MONEY

LOWER DRILL BIT COSTS

- Use standard ANSI bits instead of proprietary bits
- Single piece design, no nut and washer to assemble

USE STANDARD ANSI BITS

- No special proprietary bits to purchase or lose
- Reduce chances for anchor failure due to incorrect bit usage

Sawtooth Threads™

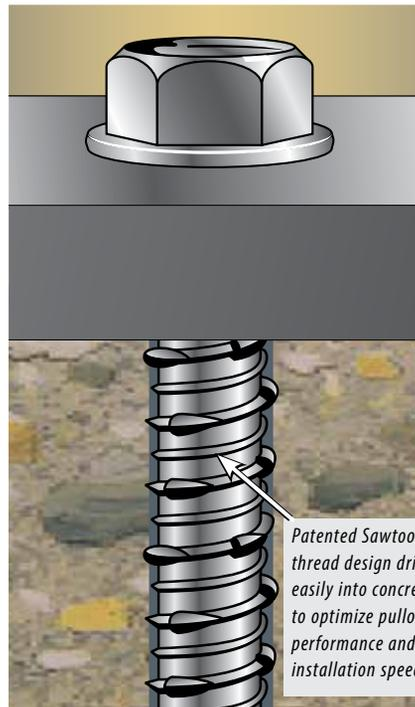

IMPROVED PERFORMANCE IN LARGE DIAMETER HOLES

- Superior performance to wedge anchor
- Higher loads in shallow embedments
- Closer edge/spacing distance than mechanical anchors
- More threads for better thread engagement and higher pullout resistance
- Durable induction-hardened tip

EASY INSTALLATION

- Easy 2-step installation, simply drill a pilot hole and drive
- Installs in less than half the time of a wedge anchor
- Efficient thread cutting
- Use standard drill bit sizes
- Single piece design—no nut and washer assembly
- Easily removed

APPLICATIONS



Racking, shelving and conveyors are just a few high volume applications ideal for Large Diameter Tapcon (LDT™). The ease and speed of installation of the LDT can reduce installation time to less than half the time of typical systems used today.



For installation speed, high performance and easy removability, LDT is the anchor of choice.

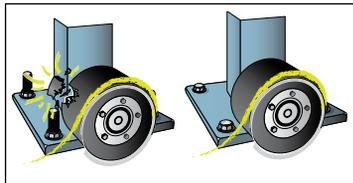

The LDT's finished head and lack of exposed threads virtually eliminates tire damage on fork lift trucks.

FEATURES

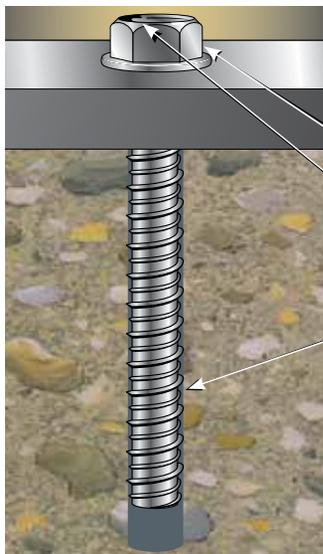

- Easy Installation**
Installs into concrete by hand or impact wrench
- Anti-rotation Serrated Washer**
— Prevents anchor back-out
- Extra Large Hex Washer Head**
— With increased bearing surface
- Length Identification Head Stamp**
— For embedment inspection after installation
- Hi-Lo Threads**
— Cuts its own threads into concrete for greater pull-out resistance

INSTALLATION STEPS

Installation Steps for Concrete, Lightweight Concrete and Metal Deck

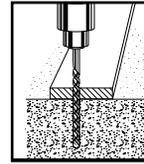

1. Using the proper size carbide bit (see chart) drill "a pilot hole at least 1" deeper than anchor embedment.

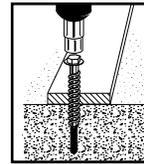

2. Using an electric impact wrench, or socket wrench (hand install) insert anchor into hole and tighten anchor until fully seated. (see chart for socket size) (do not over tighten).

Installation Steps for Hollow or Grout-Filled CMU (3/8" and 1/2" diameter)

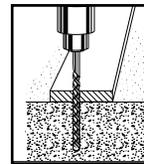

1. Using a 5/16" (for 3/8" LDT) or 7/16" (for 1/2" LDT) carbide tipped bit, drill a pilot hole at least 1" deeper than anchor embedment.

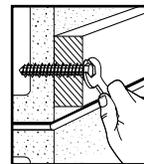

2. Using a socket wrench insert anchor into hole and hand tighten anchor until fully seated. (9/16" socket for 3/8" and 3/4" socket for 1/2") (do not over tighten).



LDT's can be installed by hand or with an impact wrench

Installation by hand—is easy, simply using a socket wrench



Installation by impact wrench—is recommended for faster installations or for high volume projects. Installation with impact wrench—is **not** recommended for hollow block.

INSTALLATION GUIDE

LDT Size	ANSI Standard Drill Bit Diameter	A Anchor Head (Socket Size) Diameter	Washer Diameter	B Minimum Embedment	C Hole Depth	USE IN		
						Concrete	CMU	
						Hollow	Grout-filled*	
LDT 3/8"	5/16"	9/16"	13/16"	1-1/2"	2-1/2"	YES	YES	YES

Ⓒ See catalog for effective lengths and length indication code. *please call technical service for grout-filled instructions.

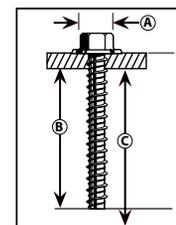

SELECTION CHART

LDT Carbon Steel with Zinc Plating

Meets ASTM B695 and B633 specifications for zinc plating of 5um = .0002" thickness.
This material is well suited for non-corrosive interior environments.



PART NUMBER FOR CARBON STEEL	ANCHOR DIA. In. (mm)	DRILL BIT DIA. In. (mm)	EFFECTIVE LENGTH In. (mm) (see detail on left)	MAX. THICKNESS OF MATERIAL TO BE FASTENED In. (mm)	QTY/WT PER BOX lbs.	QTY/WT PER MASTER CARTON lbs.
LDT-3816	3/8 (9.5)	5/16 (7.9)	1-3/4 (44.5)	1/4 (6.4)	50/ 3.0	400/ 24.0
LDT-3824	3/8 (9.5)	5/16 (7.9)	2-1/2 (63.5)	1 (25.4)	50/ 4.5	400/ 34.0
LDT-3840	3/8 (9.5)	5/16 (7.9)	4 (101.6)	2-1/2 (63.5)	50/ 6.5	400/ 52.0
LDT-5840	5/8 (15.9)	1/2 (12.7)	4 (101.6)	1-1/4 (31.8)	10/ 4.0	100/ 40.0
LDT-5860	5/8 (15.9)	1/2 (12.7)	6 (152.4)	3-1/4 (82.6)	10/ 5.4	50/ 27.0

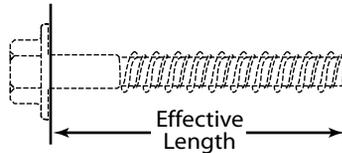

DESIGN GUIDE

For proper selection of anchor diameters based upon predrilled holes in base plates and fixtures.

HOLE DIAMETER IN FIXTURE In. (mm)	SUGGESTED LDT DIAMETER In. (mm)
7/16 (11.1)	3/8 (9.5)
1/2 (12.7)	3/8 (9.5)
3/4 (19.1)	5/8 (15.9)

LENGTH INDICATION CODE*



CODE	LENGTH OF ANCHOR In. (mm)
A	1-1/2 < 2 (38.1 < 50.8)
B	2 < 2-1/2 (50.8 < 63.5)
C	2-1/2 < 3 (63.5 < 76.2)
D	3 < 3-1/2 (76.2 < 88.9)
E	3-1/2 < 4 (88.9 < 101.6)
F	4 < 4-1/2 (101.6 < 114.3)
G	4-1/2 < 5 (114.3 < 127.0)
H	5 < 5-1/2 (127.0 < 139.7)
I	5-1/2 < 6 (139.7 < 152.4)
J	6 < 6-1/2 (152.4 < 165.1)

*Located on top of anchor for easy inspection.

PERFORMANCE TABLE

LDT Anchors Ultimate Tension and Shear Values (Lbs/kN) in Concrete

ANCHOR DIA. In. (mm)	EMBEDMENT DEPTH In. (mm)	$f'_c = 2000 \text{ PSI (13.8 MPa)}$		$f'_c = 3000 \text{ PSI (20.7 MPa)}$		$f'_c = 4000 \text{ PSI (27.6 MPa)}$	
		TENSION Lbs. (kN)	SHEAR Lbs. (kN)	TENSION Lbs. (kN)	SHEAR Lbs. (kN)	TENSION Lbs. (kN)	SHEAR Lbs. (kN)
3/8 (9.5)	1-1/2 (38.1)	1,336 (5.9)	2,108 (9.4)	1,652 (7.3)	2,764 (12.3)	1,968 (8.8)	3,416 (15.2)
	2 (50.8)	1,492 (6.6)	3,036 (13.5)	2,024 (9.0)	3,228 (14.4)	2,552 (11.4)	3,420 (15.2)
	2-1/2 (63.5)	3,732 (16.6)	3,312 (14.7)	3,748 (16.7)	3,364 (15.0)	3,760 (16.7)	3,424 (15.2)
	3-1/2 (88.9)	5,396 (24.0)	3,312 (14.7)	6,624 (29.5)	3,368 (15.0)	7,852 (34.9)	3,428 (15.2)
5/8 (15.9)	2-3/4 (69.9)	5,276 (23.5)	8,656 (38.5)	6,560 (29.2)	11,064 (49.2)	7,844 (34.8)	13,476 (59.9)
	3-1/2 (88.9)	7,972 (35.5)	10,224 (45.5)	9,848 (43.8)	12,144 (54.0)	11,724 (52.2)	14,060 (62.5)

For allowable values use a 4 to 1 safety factor (Ultimate/4 or Ultimate*0.25)"

PERFORMANCE TABLE

LDT Anchors Recommended Edge & Spacing Requirements for Tension Loads* Carbon Steel

ANCHOR DIA. In. (mm)	EMBEDMENT DEPTH In. (mm)	EDGE DISTANCE REQUIRED TO OBTAIN MAX. WORKING LOAD In. (mm)	LOAD FACTOR APPLIED AT MIN. EDGE DISTANCE 1-3/4 Inches (44mm)	SPACING DISTANCE REQUIRED TO OBTAIN MAX. WORKING LOAD In. (mm)	LOAD FACTOR APPLIED AT MIN. SPACING DISTANCE 3 Inches (76mm)
3/8 (9.5)	1-1/2 (38.1)	2 (50.8)	70%	6 (152.4)	44%
	2 (50.8)	2 (50.8)	70%	6 (152.4)	44%
	2-1/2 (63.5)	3 (76.2)	70%	6 (152.4)	44%
	3-1/2 (88.9)	4 (101.6)	70%	6 (152.4)	44%
5/8 (15.9)	2-3/4 (69.9)	6-1/4 (158.8)	65%	10 (254.0)	50%
	3-1/2 (88.9)	6-1/4 (158.8)	65%	10 (254.0)	50%

* Edge and spacing distance shall be divided by .75 when anchors are placed in structural lightweight concrete. Linear interpolation may be used for intermediate spacing and edge distances.

For 5/8" and 3/4" LDT Anchors, the critical edge distance for these anchors is 10 times the anchor diameter. The edge distance of these anchors may be reduced to 1-3/4" provided a 0.65 load factor is used for tension loads, a 0.15 load factor is used for shear loads applied perpendicular to the edge, or a 0.60 load factor is used for shear loads applied parallel to the edge. Linear interpolation may be used for intermediate edge distances.

LDT Anchors Recommended Edge & Spacing Requirements for Shear Loads* Carbon Steel

ANCHOR DIA. In. (mm)	EMBEDMENT DEPTH In. (mm)	EDGE DISTANCE REQUIRED TO OBTAIN MAX. WORKING LOAD In. (mm)	LOAD FACTOR APPLIED AT MIN. EDGE DISTANCE 1-3/4 Inches (44mm)	SPACING DISTANCE REQUIRED TO OBTAIN MAX. WORKING LOAD In. (mm)	LOAD FACTOR APPLIED AT MIN. SPACING DISTANCE 3 Inches (76mm)
3/8 (9.5)	1-1/2 (38.1)	3 (76.2)	25%	6 (152.4)	57%
	2 (50.8)	4 (101.6)	25%	6 (152.4)	57%
	2-1/2 (63.5)	5 (127.0)	25%	6 (152.4)	57%
	3-1/2 (88.9)	5 (127.0)	25%	6 (152.4)	57%
5/8 (15.9)	2-3/4 (69.9)	6-1/4 (158.8)	15%** / 60%***	10 (254.0)	75%
	3-1/2 (88.9)	6-1/4 (158.8)	15%** / 60%***	10 (254.0)	75%

* Edge and spacing distances shall be divided by .75 when anchors are placed in structural lightweight concrete. Linear interpolation may be used for intermediate spacing and edge distances.

** 15% = shear load applied perpendicular to the edge

*** 60% = shear load applied parallel to the edge

LDT Anchors Ultimate Tension Load (Lbs/kN) in Concrete Block (anchors should be installed by hand in hollow block)

ANCHOR DIA. In. (mm)	EMBEDMENT DEPTH In. (mm)	HOLLOW CONCRETE BLOCK		GROUT FILLED CONCRETE BLOCK	
		TENSION Lbs. (kN)	SHEAR Lbs. (kN)	TENSION Lbs. (kN)	SHEAR Lbs. (kN)
3/8 (9.5)	1-1/2 (38.1)	916 (4.1)	3,176 (14.1)	1,592 (7.1)	3,900 (17.3)

PERFORMANCE TABLE

LDT Anchors

Allowable Tension and Shear* (Lbs/kN) in Concrete Block (anchors should be installed by hand in hollow block)

ANCHOR DIA. In. (mm)	EMBEDMENT DEPTH In. (mm)	HOLLOW CONCRETE BLOCK		GROUT FILLED CONCRETE BLOCK	
		TENSION Lbs. (kN)	SHEAR Lbs. (kN)	TENSION Lbs. (kN)	SHEAR Lbs. (kN)
3/8 (9.5)	1-1/2 (38.1)	229 (1.0)	794 (3.5)	398 (1.8)	975 (4.3)

* Allowable values are based upon a 4 to 1 safety factor. (Ultimate/4)

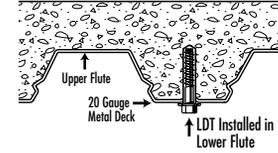

LDT Anchors

Anchoring Overhead in 3000 PSI Lightweight Concrete On Metal Deck

ANCHOR	DRILL HOLE DIAMETER In. (mm)	EMBEDMENT In. (mm)	3000PSI (20.7 MPa) CONCRETE			
			ULTIMATE TENSION LOAD Lbs. (kN)		ALLOWABLE WORKING LOAD Lbs. (kN)	
3/8" LDT	5/16 (7.9)	1-1/2 (38.1)	Upper Flute	2,889 (12.9)	722 (3.2)	
			Lower Flute	1,862 (8.3)	465 (2.1)	

The Easy, Fast, High Performing, Removable Tapcon Anchor, Available in 3/8" and 5/8" Diameter

1/2" LDT	1/2" adhesive	5/8" wedge
INSTALLS IN 1/2 THE TIME	DIFFICULT TO REMOVE	PERMANENT APPLICATION
EASILY REMOVED	EXPOSED THREADS	EXPOSED THREADS
FINISHED HEAD	5-STEP INSTALLATION	DIFFICULT TO REMOVE
	CURE TIME	

DRILL BIT SIZE REQUIRED	7/16" DRILL BIT	9/16" DRILL BIT	5/8" DRILL BIT
HOLE DEPTH REQUIRED	4-1/2"	4-1/2"	7"

DRILL BIT SIZE REQUIRED
LDT anchors specify a smaller & less expensive drill bit than those required with the 1/2" adhesive threaded rod or the 5/8" wedge.

HOLE DEPTH REQUIRED
At 4-1/2" embedment the LDT anchor will give you performance (2000 PSI concrete) similar to 1/2" adhesive anchor of the same depth or 5/8" wedge anchors at 7" deep. (2000 PSI concrete)

Tapcon+[®]

Seismic and Cracked Concrete Screw Anchors

**Finished Head,
Removable Anchor**



DESCRIPTION/SUGGESTED SPECIFICATIONS

Self-threading Anchors—

SPECIFIED FOR ANCHORAGE INTO CONCRETE REQUIRING CRACKED AND SEISMIC



Tapcon+
Self-threading
Anchor

APPROVALS

Tapcon+ out performs traditional wedge anchor products, providing greater load capacity while reducing installation time by up to 50%, offering significant cost-in-place savings on the job site.

Tapcon+ is available with International Building Code (IBC) compliance and other third party listings for use in cracked concrete and seismic applications.

ADVANTAGES

In the Engineering Office:

- Leading steel strength in tension, shear, and seismic shear
- Outperforms wedge anchors in tension, shear, and anchor spacing
- 20% more holding power than wedge or sleeve anchors
- Approved for concrete in cracked, uncracked, and seismic conditions
- Simplicity of installation improves "buildability" on the job site
- Corrosion-resistance and long-lasting performance due to the innovative Blue Climaseal[®] coating

On the Job:

- More than 2x faster installation than wedge or sleeve anchors
- The ability to drive close to the edge with confidence
- Removable for temporary fixing
- Installs without hammering and precision torque wrench
- One fastening solution for multiple applications and materials

SELECTION CHART

DRILL BIT DIA. mm (in.)	ANCHOR OUTSIDE THREAD DIA. mm (in.)	EFFECTIVE LENGTH mm (in.)	ANCHOR HEAD (SOCKET SIZE) DIA. In.	MAX. THICKNESS MATERIAL TO BE FASTENED mm (in.)	PART NUMBER	QTY/ BOX	PART NUMBER BULK	QTY BULK BOX
6.4 (1/4)	7.9 (5/16)	57.2 (2-1/4)	3/8	6.4 (1/4)	-	-	3511407	600
6.4 (1/4)	7.9 (5/16)	76.2 (3)	3/8	25.4 (1)	-	-	3507407	100
9.5 (3/8)	11.7 (0.46)	(1-3/4)	9/16		11440C	10	-	-
9.5 (3/8)	11.7 (0.46)	(2-1/4)	9/16	6.4 (1/4)	11441C	10	-	-
9.5 (3/8)	11.7 (0.46)	76.2 (3)	9/16	12.7 (1/2)	11413C	10	3508407	300
9.5 (3/8)	11.7 (0.46)	101.6 (4)	9/16	38.1 (1-1/2)	11414C	10	3509407	200
9.5 (3/8)	11.7 (0.46)	127.0 (5)	9/16	63.5 (2-1/2)	11445C	10	-	-
9.5 (3/8)	11.7 (0.46)	152.4 (6)	9/16	88.9 (3-1/2)	11446C	10	-	-
12.7 (1/2)	14.0 (0.59)	76.2 (3)	3/4	25.4 (1)	11447C	10	-	-
12.7 (1/2)	14.0 (0.59)	101.6 (4)	3/4	50.8 (2)	11420C	10	3510207	100
12.7 (1/2)	14.0 (0.59)	127.0 (5)	3/4	76.2 (3)	11449C	10	-	-
12.7 (1/2)	14.0 (0.59)	152.4 (6)	3/4	101.6 (4)	11421C	10	3510407	100

APPLICATIONS



- Sill Plates



- Post Cap Connector

- Ledger Board



- Heavy Equipment

- Industrial Racking/Shelving

- Modular Walls

- Machinery



FEATURES



Blue ClimaSeal™ adds corrosion protection

Induction hardened tip cuts into harder concrete, increases pullout.

Consult ICC-ESR 3699 for a full technical report. Available at www.itwredhead.ca

ACCESSORIES

PART NUMBER	DESCRIPTION	BOX QTY
11493C	1/4 x 7 SDS Plus Tapcon Drill Bit	10
11494C	3/8 x 8 SDS Plus Tapcon Drill Bit	10
11495C	1/2 x 10 SDS Plus Tapcon Drill Bit	10

APPROVALS/LISTINGS

ICC ESR-3699 – Cracked & Uncracked and Seismic approved

City of Los Angeles (1/4" & 3/8" diameters)

Florida Building Code Compliant

INSTALLATION STEPS



1. Drill a hole that is at least a 1/4" deeper than the anchor embedment.

Using

Variable Speed Concrete Hammer Drill & Carbide Drill Bit

1/4 x 7" Tapcon SDS+ Drill Bit (11493C) or

3/8 x 8" Tapcon SDS+ Drill Bit (11494C) or

1/2 x 10" Tapcon SDS+ Drill Bit (11495C) or

Equivalent size ANSI Drill Bit



2. Using pressurized air or a vacuum, remove the drilling debris from the hole.

Using

Air Compressor or Standard Vacuum Cleaner

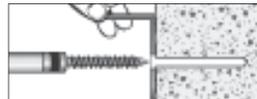

3. Drive Tapcon+ screw anchor through fixture (bracket, or attachment plate), until fully seated.

Using

Six Point Impact Socket

3/8" Socket for 1/4" Anchors

9/16" Socket for 3/8" Anchors

3/4" Socket for 1/2" Anchors

Impact Wrench

115 Max ft-lbf for 1/4" Anchors

200 Max ft-lbf for 3/8" Anchors

345 Max ft-lbf for 1/2" Anchors

Strength Design Performance Values in Accordance to CSA 23.3-14

ITW RED HEAD TAPCON+ SCREW ANCHOR

DESIGN INFORMATION TESTED TO ICC-ES AC193 AND ACI 355.2, DEFINED IN ICC ESR-3699



TAPCON+ DESIGN INFORMATION

PARAMETER	Symbol	Units	Nominal Anchor Diameter				
			1/4"		3/8"	1/2"	
Anchor outer diameter	$d_a [d_o]^2$	mm.	6.4		9.5	12.7	
Drill bit specification		in	1/4" Tapcon+ bit	1/4" ANSI bit	3/8" ANSI bit	1/2" ANSI bit	
Minimum specified yield strength	f_y	MPa	689		689	689	
Minimum specified ultimate strength	f_{uta}	MPa	862		862	862	
Effective tensile stress area	$A_{se,N} [A_{se}]^6$	mm ²	30		63	119	
Effective shear stress area	$A_{se,V} [A_{se}]^6$	mm ²	30		63	119	CSA 23.3-14
Resistance modification factor, tension, steel failure modes	R	–			0.70		D5.3
Resistance modification factor, shear, steel failure modes	R	–			0.65		D5.3
Resistance factor for steel anchors	Φ_s	–			0.85		8.4.3
Factored steel resistance, tension	N_{sar}	kN	15.5		32.4	61.2	D.6.1.2
Factored steel resistance, shear	V_{sar}	kN	14.4		30.1	56.8	D.7.1.2
Factored steel resistance, seismic shear	$V_{sar,eq}$	kN	9.5		24.3	41.9	
Effectiveness factor for uncracked concrete	k_{un-cr}	–	10		11.25	12.5	D.6.2.2
Effectiveness factor for cracked concrete	k_{cr}	–			7		D.6.2.2
Modification factor for resistance in tension to account for uncracked concrete	Ψ_c, N	–			1		D.6.2.6
Anchor category	–	–	1	2	1		
Material resistance factor for concrete	Φ_c	–			0.65		8.4.2
Strength reduction factor for tension and shear, concrete failure modes	R	Cond. A	1.15	1.00	1.15		D.5.3c
	R	Cond. B	1.00	0.85	1.00		D.5.3c
Modification Factor for concrete density	λ	–			1		8.6.5
Factored pullout resistance in 20 MPa uncracked concrete	$N_{pr, un-cr}$	kN	6.6	5.6	Pullout does not control	Pullout does not control	D.6.3.2
Factored pullout resistance in 20 MPa cracked concrete	$N_{pr, cr}$	kN	2.7	2.3	5.4	Pullout does not control	D.6.3.3
Factored seismic pullout resistance in 20 MPa cracked concrete	$N_{pr, cr}$	kN	2.7	2.3	4.9	Pullout does not control	D.6.3.3

1. The data in this table was taken from ICC ESR-3699 and converted to be used in conjunction with the design provisions of CSA 23.3-14 or CSA 23.3-04, Chapter 8 and Annex D, as applicable.
2. Installation must comply with the manufacturers printed installation instructions and details described in the ICC ESR-3699 and this ITW Red Head catalog
3. The 1/4", 3/8", and 1/2" Tapcon+ carbon steel anchors are considered brittle steel elements
4. For all design cases, $\Psi_c, N = 1$. The appropriate effectiveness factor for cracked (kcr) or uncracked concrete (kuncr) must be used.
5. Condition B was assumed for the strength reduction factor for tension and shear (concrete failure modes). For cases where the presence of supplementary reinforcement in conformance with CSA 23.3-14 D.5.3 can be verified, the modification factor for condition A may be used
6. Where Pullout strength does not control anchor design, determine steel and concrete breakout capacities only.

Strength Design Performance Values in Accordance to CSA 23.3-14

ITW RED HEAD TAPCON+ SCREW ANCHOR



TAPCON+ INSTALLATION INFORMATION

PARAMETER	SYMBOL	UNITS	Nominal Anchor Diameter				
			1/4"	3/8"	1/2"		
Head Style	-	-	Hex Head	Hex Head	Hex Head		
Anchor Outer Diameter (Shank)	$d_a [d_o]^2$	mm. (in.)	6.4 (0.25)	9.7 (0.38)	12.7 (0.50)		
Nominal carbide bit diameter	d_{bit}	in.	1/4" Tapcon+ or 1/4" ANSI Bit	3/8" ANSI Bit	1/2" ANSI Bit		
Minimum base plate clearance hole diameter	d_h	mm. (in.)	9.7 (0.38)	12.7 (0.50)	16.0 (0.63)		
Effective embedment depth	h_{ef}	mm. (in.)	36.8 (1.45)	45.2 (1.78)	33.5 (1.32)	55.1 (2.17)	76.7 (3.02)
Minimum nominal embedment depth	h_{nom}	mm. (in.)	50.8 (2)	63.5 (2-1/2)	50.8 (2)	76.2 (3)	101.6 (4)
Minimum hole depth	h_o	mm. (in.)	57.2 (2-1/4)	69.9 (2-3/4)	57.2 (2-1/4)	82.6 (3-1/4)	108 (4-1/4)
Minimum concrete member thickness	h_{min}	mm. (in.)	101.6 (4)	101.6 (4)	101.6 (4)	152.4 (6)	
Critical edge distance	c_{ac}	mm. (in.)	63.5 (2-1/2)	114.3 (4-1/2)	76.2 (3)	101.6 (4)	127.0 (5)
Minimum anchor spacing	s_{min}	mm. (in.)	76.2 (3)	76.2 (3)	76.2 (3)	88.9 (3-1/2)	76.2 (3)
Minimum edge distance	c_{min}	mm. (in.)	38.1 (1-1/2)	38.1 (1-1/2)	63.5 (2-1/2)	44.5 (1-3/4)	63.5 (2-1/2)
Maximum installation torque	$T_{inst, max}$	ft-lb	20	50	70		
Maximum installation torque	$T_{impact, max}$	ft-lb	115	200	345		

1. Use ANSI carbide tipped hammer drill bits made in accordance with ANSI B212.15-1994 to install anchors.
2. $T_{inst, max}$ applies to installations using a calibrated torque wrench



FACTORED STEEL RESISTANCE FOR TAPCON+ CARBON STEEL ANCHORS

Nominal Anchor Diameter	Effective Emb. Depth mm. (in.)	Tensile, kN (lbf)	Shear, kN (lbf)	Seismic shear, kN (lbf)
1/4	37 (1-4/9)	15.5 (3495)	14.4 (3245)	9.5 (2145)
3/8	45 (1-7/9)	32.4 (7290)	30.1 (6770)	24.3 (5460)
1/2	34 (1-1/3)	61.2 (13760)	56.8 (12775)	41.9 (9425)
	55 (2-1/6)			
	77 (3)			

1. The 1/4", 3/8", and 1/2" Tapcon+ carbon steel anchors are considered brittle steel elements
2. Tension values calculated according to Clause D6.1.2 in CSA A23.3-14 Annex D
3. Shear values calculated according to Clause D7.1.2 in CSA A23.3-14 Annex D
4. Seismic shear was calculated by reducing V_{sar} based on correlation between V_{sa} and V_{eq} from the ICC ESR-3699

Strength Design Performance Values in Accordance to CSA 23.3-14

ITW RED HEAD TAPCON+ SCREW ANCHOR



FACTORED CONCRETE BREAKOUT/PULLOUT, TENSION kN (lbf)

Nominal Anchor Diameter (in.)	Effective Embedment Depth (in.)	Nominal Embedment Depth mm. (in.)	Concrete Compressive Strength (Uncracked)					Concrete Compressive Strength (Cracked)				
			20 MPa (2900)	25 MPa (3625)	30 MPa (4350)	40 MPa (5800)	50 MPa (7250)	20 MPa (2900)	25 MPa (3625)	30 MPa (4350)	40 MPa (5800)	50 MPa (7250)
1/4	37 (1-4/9)	51 (2)	5.6 (1250)	6.2 (1395)	6.8 (1530)	7.9 (1765)	8.8 (1975)	2.3 (510)	2.5 (570)	2.8 (625)	3.2 (720)	3.6 (805)
3/8	45 (1-7/9)	64 (2-1/2)	9.9 (2235)	11.1 (2500)	12.2 (2735)	14.1 (3160)	15.7 (3535)	5.4 (1215)	6.0 (1360)	6.6 (1490)	7.6 (1720)	8.6 (1920)
1/2	34 (1-1/3)	51 (2)	7.1 (1585)	7.9 (1775)	8.6 (1940)	10.0 (2245)	11.2 (2505)	4.0 (890)	4.4 (995)	4.8 (1090)	5.6 (1255)	6.2 (1405)
	55 (2-1/6)	76 (3)	14.9 (3345)	16.6 (3735)	18.2 (4095)	21.0 (4725)	23.5 (5285)	8.3 (1870)	9.3 (2095)	10.2 (2295)	11.8 (2645)	13.2 (2960)
	77 (3)	102 (4)	24.4 (5490)	27.3 (6135)	29.9 (6720)	34.5 (7760)	38.6 (8675)	13.7 (3075)	15.3 (3435)	16.7 (3765)	19.3 (4345)	21.6 (4860)

1. Linear interpolation between embedment depths and concrete compressive strength is not permitted.
2. Single anchor with no spacing, edge distance, and concrete thickness factors included. Apply these factor according to project condition and compare to steel values to determine anchor strength for design.
3. Tabular values are for normal weight concrete only. For different concrete densities, apply modification factors according to CSA 23.3-14 8.6.5
4. Tabular values are for static loads only. For seismic tension refer to section 4.1.8 of the ICC ESR-3699.
5. Values are for Condition B in conformance with CSA 23.3-14 D.5.3
6. ANSI carbide bit drilling was assumed for all diameters. If using a 1/4" Tapcon+ drill bit, cracked and uncracked pullout of 1/4" Tapcon+ can be multiplied by 1.18

FACTORED CONCRETE PRYOUT/STEEL, RESISTANCE, SHEAR kN (lbf)

Nominal Anchor Diameter (in.)	Effective Embedment Depth mm. (in.)	Nominal Embedment Depth mm. (in.)	Concrete Compressive Strength (Uncracked)					Concrete Compressive Strength (Cracked)				
			20 MPa (2900)	25 MPa (3625)	30 MPa (4350)	40 MPa (5800)	50 MPa (7250)	20 MPa (2900)	25 MPa (3625)	30 MPa (4350)	40 MPa (5800)	50 MPa (7250)
1/4	37 (1-4/9)	51 (2)	5.5 (1240)	6.2 (1395)	6.8 (1530)	7.8 (1755)	8.7 (1965)	2.3 (870)	4.3 (970)	4.7 (1065)	5.5 (1230)	6.1 (1375)
3/8	45 (1-7/9)	64 (2-1/2)	9.9 (2235)	11.1 (2500)	12.2 (2735)	14.1 (3160)	15.7 (3535)	6.2 (1390)	6.9 (1555)	7.6 (1705)	8.7 (1965)	9.5 (2200)
1/2	34 (1-1/3)	51 (2)	7.1 (1585)	7.9 (1775)	8.6 (1940)	10.0 (2245)	11.2 (2505)	4.0 (890)	4.4 (995)	4.8 (1090)	5.6 (1255)	6.2 (1405)
	55 (2-1/6)	76 (3)	14.9 (3345)	16.6 (3735)	18.2 (4095)	21.0 (4725)	23.5 (5285)	8.3 (1870)	9.3 (2095)	10.2 (2295)	11.8 (2645)	13.2 (2960)
	77 (3)	102 (4)	48.8 (10975)	54.6 (12270)	56.8 (12775)	56.8 (12775)	56.8 (12775)	27.3 (6145)	30.6 (6870)	33.5 (7530)	38.7 (8695)	43.2 (9720)

1. Linear interpolation between embedment depths and concrete compressive strength is not permitted.
2. Single anchor with no spacing, edge distance, and concrete thickness factors included. Apply these factor according to project condition and compare to steel strength values to determine anchor strength for design.
3. Tabular values are for normal weight concrete only. For different concrete densities, apply modification factors according to CSA 23.3-14 8.6.5
4. Tabular values are for static loads only. For seismic shear compare values in this table with steel strength values.
5. Values are for Condition B in conformance with CSA 23.3-14 D.5.3

Multi-Set II Drop-In Anchors

**Internally
Threaded Heavy-
Duty Anchoring
Systems**

DESCRIPTION/SUGGESTED SPECIFICATIONS

Drop-In, Shell-Type Anchors—

SPECIFIED FOR ANCHORAGE INTO CONCRETE

Drop-In, shell-type anchors feature an internally threaded, all-steel shell with expansion cone insert and flush embedment lip. Anchors are manufactured from zinc-plated carbon steel, 18-8 stainless steel.

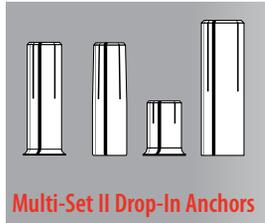

Multi-Set II Drop-In Anchors

Anchors should be installed with carbide tipped hammer drill bits made in accordance to ANSI B212.15-1994 specifications.

Anchors should be tested to ASTM E488 criteria. Anchors should also be listed by the following agencies as required by the local building code: UL, FM, City of Los Angeles, California State Fire Marshal and Caltrans.

ADVANTAGE

Depth Charge Stop Drill Anchors



- Shoulder prevents over drilling
- Less likely to hit reinforcing steel or post-tension cable in concrete
- No lost time or energy drilling farther than necessary
- Anchor is set at a specified depth, does not drop too far into hole

RM Drop-In Anchor



- Lipped anchor body keeps anchor flush
- Easy installation
- Keeps all rods same length
- Easy inspection
- Available in carbon steel, 18-8

RX Drop-In Anchor



- Optimized for use in hollow-core, pre-cast plank and post-tension slabs
- Lip keeps anchor flush during installation
- Shallow drilling—fast installation

RL Drop-In Anchor



- Below surface setting for easy patch work
- Higher performance potential with deep embedment setting

APPLICATIONS



Pumps and heavy piping are common applications for larger diameter Multi-Set Drop-In Anchors.



Cable tray and strut suspended from concrete ceilings are ideal Multi-Set applications. In post-tension or hollow-core slabs use the RX-38.



The Multi-Set Anchor is the standard for pipe-hanging. The RM version has a retainer lip to keep all anchors flush at the surface, keeping all your threaded rod the same length.

FEATURES

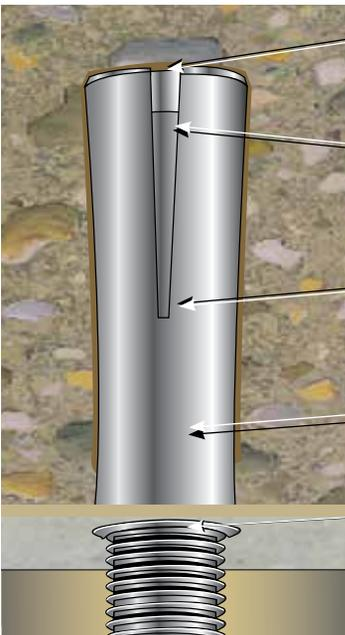

Expander Slots—allow for easy setting and superior performance

Cone Insert—that expands the anchor when driven with setting tool and hammer

Body—available in zinc-plated steel, 18-8 stainless steel

Easy Depth Inspection—keeps threaded rod drop lengths consistent

Retainer Lip—to keep anchor flush with surface

For use with threaded rods or headed bolts (supplied by contractor)



PART NUMBER RT-138

1 setting tool per master carton
(See page RH 54 for part numbers.)

APPROVALS/LISTINGS

Underwriters Laboratories
Factory Mutual

INSTALLATION STEPS

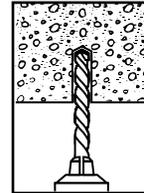

To set anchor flush with surface:

1. Drill hole to required embedment (see Table on page RH 63).

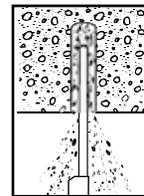

2. Clean hole with pressurized air.

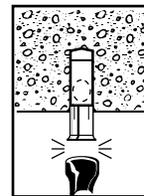

3. Drive anchor flush with surface of concrete.

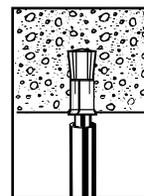

4. Expand anchor with setting tool provided (see chart on page RH 61). Anchor is properly expanded when shoulder of setting tool is flush with top of anchor.

To set anchor below surface:

Drill hole deeper than anchor length. Thread bolt into anchor. Hammer anchor into hole until bolt head is at desired depth. Remove bolt and set anchor with setting tool.



PART NUMBER RTX-138

For use with RX-38 only.



PART NUMBER RTX-112

For use with RX-12 only.

SELECTION CHART

Multi-Set II Drop-In Anchors

One setting tool per master carton.
For continuous extreme low temperature, use stainless steel.

USER TYPE	APPLICATION	BASE MATERIAL	CORROSION RESISTANCE LEVEL	DROP-IN ANCHOR TYPE	PART NUMBER	SETTING TOOL PART NUMBER	BOLT SIZE-THREADS PER INCH	DRILL BIT DIA. In. (mm)	THREAD DEPTH In. (mm)	EMBEDMENT MIN. HOLE DEPTH In. (mm)	QTY/WT PER BOX lbs.	QTY/WT PER MASTER CTN lbs.
	HVAC/Fire Sprinkler	Solid concrete/lightweight fill deck	Low	RM	RM-38* +	RT-138	3/8" - 16	1/2 (12.7)	1/2 (12.7)	1-5/8 (41.3)	50/ 3.4	500/ 36
					RM-12* +	RT-112	1/2" - 13	5/8 (15.9)	3/4 (19.1)	2 (50.8)	50/ 5.8	400/ 49
	Hollow-core pre-cast or Post-tension	Solid concrete/lightweight fill deck	Low	RX	RX-38*	RTX-138	3/8" - 16	1/2 (12.7)	3/8 (9.5)	3/4 (19.1)	100/ 3.5	1000/ 36
					RX-12	RTX-112	1/2" - 13	5/8 (15.9)	1/2 (12.7)	1 (25.4)	50/ 3.0	500/ 31
	Concrete Cutting/Sawing Contractor/Misc. Metal	Solid concrete/lightweight fill deck	Low	RL (w/o lip)	RL-14	RT-114	1/4" - 20	3/8 (9.5)	3/8 (9.5)	1 (25.4)	100/ 2.6	1000/ 28
					RL-38	RT-138	3/8" - 16	1/2 (12.7)	1/2 (12.7)	1 - 5/8 (41.3)	50/ 3.4	500/ 36
					RL-12	RT-112	1/2" - 13	5/8 (15.9)	3/4 (19.1)	2 (50.8)	50/ 5.8	400/ 49
					RL-58	RT-158	5/8" - 11	7/8 (22.2)	1 (25.4)	2 - 1/2 (63.5)	25/ 7.8	125/ 41
					RL-34	RT-134	3/4" - 10	1 (25.4)	1-1/4 (31.8)	3-3/16 (81.0)	25/11.9	100/ 49

* FM Approved

+ UL Approved

Multi-Set II Depth Charge Anchors

PART NUMBER	DESCRIPTION	DRILL DEPTH
DC-38	1/2" x 1-11/16" CARBIDE DRILL BIT FOR 3/8" DROP-IN	1-11/16"
DC-12	5/8" x 2-1/16" CARBIDE DRILL BIT FOR 1/2" DROP-IN	2-1/16"
DCX-138	1/2" x 13/16" CARBIDE DRILL BIT FOR 3/8" STUBBY DROP-IN	13/16"

DepthCharge™

Stop Drill



- Shoulder prevents over drilling
- Less likely to hit reinforcing steel or post-tension cable in concrete

- No lost time or energy drilling farther than necessary
- Anchor is set at a specified depth, does not drop too far into hole

PERFORMANCE TABLES

Multi-Set II Drop-In Anchors

Ultimate Tension and Shear Values (Lbs/kN) in Concrete*

BOLT DIA. In. (mm)	ANCHOR DIA. In. (mm)	MIN. EMBEDMENT DEPTH In. (mm)	ANCHOR TYPE	TENSION Lbs. (kN)			SHEAR Lbs. (kN)
				f _c = 2000 PSI (13.8 MPa)	f _c = 4000 PSI (27.6 MPa)	f _c = 6000 PSI (41.4 MPa)	f _c > 2000 PSI (13.8 MPa)
1/4 (6.4)	3/8 (9.5)	1 (25.4)	RM, RL or CL-Carbon or SRM-18-8 S.S.	1,680 (7.5)	2,360 (10.5)	2,980 (13.3)	1,080 (4.8)
3/8 (9.5)	1/2 (12.7)	1-5/8 (41.3)		2,980 (13.3)	3,800 (16.9)	6,240 (27.8)	3,160 (14.1)
1/2 (12.7)	5/8 (15.9)	2 (50.8)		3,300 (14.7)	5,840 (26.0)	8,300 (36.9)	4,580 (20.4)
5/8 (15.9)	7/8 (22.2)	2-1/2 (63.5)		5,500 (24.5)	8,640 (38.4)	11,020 (49.0)	7,440 (33.1)
3/4 (19.1)	1 (25.4)	3-3/16 (81.0)		8,280 (36.8)	9,480 (42.2)	12,260 (54.5)	10,480 (46.6)

* Allowable values are based upon a 4 to 1 safety factor. Divide by 4 for allowable load values.

* For continuous extreme low temperature applications, use stainless steel.

PERFORMANCE TABLES

Multi-Set II Drop-In Anchors Ultimate Tension and Shear Values (Lbs/kN) in Lightweight Concrete*

BOLT DIA. In. (mm)	ANCHOR DIA. In. (mm)	MINIMUM EMBEDMENT DEPTH In. (mm)	ANCHOR TYPE	LIGHTWEIGHT CONCRETE f'c = 3000 PSI (20.7 MPa)		LOWER FLUTE OF STEEL DECK WITH LIGHTWEIGHT CONCRETE FILL f'c = 3000 PSI (20.7 MPa)	
				TENSION Lbs. (kN)	SHEAR Lbs. (kN)	TENSION Lbs. (kN)	SHEAR Lbs. (kN)
3/8 (9.5)	1/2 (12.7)	1-5/8 (39.7)	RM, RL or CL-Carbon or SRM-18-8 S.S.	3,860 (17.2)	4,420 (19.6)	3,340 (14.9)	4,420 (19.6)
1/2 (12.7)	5/8 (15.9)	2 (50.8)		4,080 (18.1)	5,640 (25.1)	3,200 (14.2)	4,940 (22.0)
5/8 (15.9)	7/8 (22.2)	2-1/2 (63.5)		6,280 (27.9)	10,440 (46.4)	5,960 (26.5)	5,840 (26.0)
3/4 (19.1)	1 (25.4)	3-3/16 (81.0)		11,000 (48.9)	15,780 (70.2)	8,180 (36.4)	9,120 (40.6)

* Allowable values are based upon a 4 to 1 safety factor. Divide by 4 for allowable load values.

Multi-Set II Drop-In Anchors Recommended Edge and Spacing Distance Requirements*

BOLT DIA. In. (mm)	DRILL BIT SIZE In. (mm)	EMBEDMENT DEPTH In. (mm)	ANCHOR TYPE	EDGE DISTANCE REQUIRED TO OBTAIN MAX. WORKING LOAD In. (mm)	MIN. EDGE DISTANCE AT WHICH LOAD FACTOR APPLIED =.80 FOR TENSION =.70 FOR SHEAR In. (mm)	SPACING REQUIRED TO OBTAIN MAX. WORKING LOAD In. (mm)	MIN. ALLOWABLE SPACING BETWEEN ANCHORS LOAD FACTOR APPLIED =.80 FOR TENSION =.55 FOR SHEAR In. (mm)
1/4 (6.4)	3/8 (9.5)	1 (25.4)	RM, RL or CL-Carbon or SRM-18-8 S.S.	1-3/4 (44.5)	7/8 (22.2)	3-1/2 (88.9)	1-3/4 (44.5)
3/8 (9.5)	1/2 (12.7)	1-5/8 (41.3)		2-7/8 (73.0)	1-7/16 (36.5)	5-11/16 (144.5)	2-7/8 (73.0)
1/2 (12.7)	5/8 (15.9)	2 (50.8)		3-1/2 (88.9)	1-3/4 (44.5)	7 (177.8)	3-1/2 (88.9)
5/8 (15.9)	7/8 (22.2)	2-1/2 (63.5)		4-3/8 (111.1)	2-3/16 (55.6)	8-3/4 (222.3)	4-3/8 (111.1)
3/4 (19.1)	1 (25.4)	3-3/16 (81.0)		5-5/8 (142.9)	2-13/16 (71.4)	11-3/16 (284.2)	5-5/8 (142.9)

* Spacing and edge distances shall be divided by 0.75 when anchors are placed in structural lightweight concrete. Linear interpolation may be used for intermediate spacing and edge distances.

Multi-Set II Drop-In Anchors Ultimate Tension and Shear Values (Lbs/kN) for RX-series (3/4" and 1" Embedment)*

BOLT DIA. In. (mm)	DRILL BIT SIZE In. (mm)	EMBEDMENT In. (mm)	2500 PSI (17.2 MPa) CONCRETE		4000 PSI (27.6 MPa) CONCRETE		HOLLOW CORE	
			TENSION Lbs. (kN)	SHEAR Lbs. (kN)	TENSION Lbs. (kN)	SHEAR Lbs. (kN)	TENSION Lbs. (kN)	SHEAR Lbs. (kN)
3/8 (9.5)	1/2 (12.7)	3/4 (19.1)	1,571 (7.0)	2,295 (10.2)	1,987 (8.8)	2,903 (12.9)	1,908 (8.5)	2,401 (10.7)
1/2 (12.7)	5/8 (15.9)	1 (25.4)	2,113 (9.4)	2,585 (11.5)	2,673 (11.9)	3,270 (14.5)	2,462 (11.0)	2,401 (10.7)

* The tabulated values are for RX anchors installed at a minimum of 12 diameters on center and minimum edge distance of 6 diameters for 100 percent anchor efficiency. Spacing and edge distance may be reduced to 6 diameters spacing and 3 diameter edge distance provided the values are reduced 50 percent. Linear Interpolation may be used for intermediate spacings and edge margins.

* Allowable values are based upon a 4 to 1 safety factor. Divide by 4 for allowable load values.

Multi-Set II Drop-In Anchors Anchoring Overhead in 3000 PSI Lightweight Concrete On Metal Deck

ANCHOR	DRILL HOLE DIAMETER In. (mm)	EMBEDMENT In. (mm)	3000PSI (20.7 MPa) CONCRETE			
			ULTIMATE TENSION LOAD Lbs. (kN)		ALLOWABLE WORKING LOAD Lbs. (kN)	
RX-38 Drop-In	1/2 (12.7)	3/4 (19.1)	Upper Flute	1,410 (6.3)	353 (1.6)	
			Lower Flute	1,206 (5.4)	301 (1.3)	

* Allowable values are based upon a 4 to 1 safety factor. Divide by 4 for allowable load values.

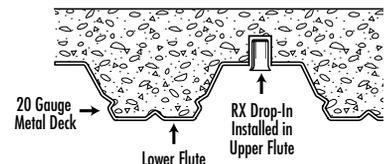

Combined Tension and Shear Loading—for Multi-Set Anchors

Allowable loads for anchors subjected to combined shear and tension forces are determined by the following equation:

$$(Ps/Pt)^{5/3} + (Vs/Vt)^{5/3} \leq 1$$

Ps = Applied tension load

Vs = Applied shear load

Pt = Allowable tension load

Vt = Allowable shear load

Dynabolt[®] Sleeve Anchors

**Versatile,
Medium-Duty
Sleeve Anchor**



**Dynabolt
Hex Nut Sleeve Anchor**

DESCRIPTION/SUGGESTED SPECIFICATIONS

Sleeve Type Anchors—

SPECIFIED FOR ANCHORAGE INTO CONCRETE, MASONRY, GROUT-FILLED BLOCK AND HOLLOW BLOCK



**Dynabolt
Masonry
Sleeve
Anchor**

Sleeve type anchors feature a split expansion sleeve over a threaded stud bolt body and integral expander, nut and washer.

Anchors are made of Plated Carbon Steel.

Anchors should be installed with carbide tipped hammer drill bits made in accordance to ANSI B212.15-1994.

Anchors are tested to ASTM E488 criteria.

ADVANTAGES

- Anchor diameter equals hole diameter
- Available in Hex head and Phillips Flat head
- Available 5/16 - 5/8" diameter up to 6-1/4" length
- Zinc plated carbon steel
- Provides full 360° hole contact over large area and reduces concrete stress
- Heavy-loading capacity
- Preassembled for faster, easier installations
- Dynabolt can be installed through object to be fastened
- Sleeve design improves holding power
- No pre-spotting of holes necessary

Available Head Styles

Full range of head style, corrosion protection, and sizes makes the Dynabolt Sleeve the right product for almost any application.

Phillips
Flat Head
(FS)

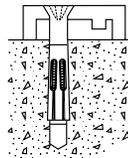

Hex Nut
(HN)

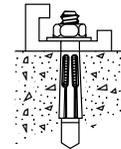

INSTALLATION STEPS

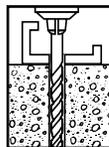

1. Use a bit with a diameter equal to the anchor. See selection chart to determine proper size bit for anchor used. Drill hole to any depth exceeding minimum embedment. Clean hole.

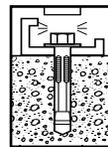

2. Insert assembled anchor into hole, so that washer or head is flush with materials to be fastened.

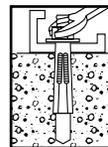

3. Expand anchor by tightening nut or head 2 to 3 turns.

APPLICATIONS



Electrical junction boxes are common applications for the Dynabolt Sleeve anchor because it works well in solid concrete, concrete block, and brick. It is also available in several finished head styles.



The Dynabolt Sleeve anchor works well in hollow materials like brick and block. It is available in zinc-plated carbon steel.



Door and window frames are commonly attached to the structure with Dynabolt Sleeve anchors because of their finished & threshold head styles and performance in block & brick.

APPROVALS/LISTINGS

Meets or exceeds U.S. Government G.S.A. Specification A-A-1922A (Formerly GSA: FF-S-325 Group II, Type 3, Class 3)

Factory Mutual

California State Fire Marshal

SELECTION CHART

Dynabolt Carbon Steel with Zinc Plating



Typical Applications—
Shelf ledgers, electrical boxes,
conduit

Environment—Interior
(non-corrosive)

Level of Corrosion—Low

HEAD STYLE	PART NUMBER	ANCHOR DIA. & DRILL BIT SIZE	EFFECTIVE ANCHOR LENGTH* In. (mm)	BOLT DIA./ THREADS PER INCH	MIN. EMBEDMENT In. (mm)	MAX. THICKNESS OF MATERIAL TO BE FASTENED In. (mm)	QTY/WT PER BOX lbs.	QTY/WT PER MASTER CARTON lbs.
HEX NUT	HN-1614	5/16"	1-1/2 (38.1)	1/4" /20	1-1/4 (31.8)	1/4 (6.4)	100/ 4.0	1000/ 41
	HN-3817*	3/8"	1-7/8 (47.6)	5/16" /18	1-1/2 (38.1)	3/8 (9.5)	50/ 3.5	500/ 36
	HN-3830*		3 (76.2)	5/16" /18	1-1/2 (38.1)	1-1/2 (38.1)	50/ 4.9	400/ 40
	HN-1222*	1/2"	2-1/4 (57.2)	3/8" /16	1-7/8 (47.6)	3/8 (9.5)	25/ 3.3	250/ 34
	HN-1230*		3 (76.2)	3/8" /16	1-7/8 (47.6)	1-1/8 (28.6)	25/ 4.0	200/ 33
	HN-1240*		4 (101.6)	3/8" /16	1-7/8 (47.6)	2-1/8 (54.0)	25/ 5.3	200/ 44
	HN-1260*		6 (152.4)	3/8" /16	1-7/8 (47.6)	4-1/8 (104.8)	20/ 5.6	200/ 56
HN-5842*		5/8"	4-1/4 (108.0)	1/2" /13	2 (50.8)	2-1/4 (57.2)	10/ 3.9	100/ 41
PHILLIPS FLAT HEAD	FS-3850	3/8"	5 (127.0)	5/16" /18	1-1/2 (38.1)	3-1/2 (88.9)	50/ 5.6	300/ 40

* FM Approved
Phillips flat head uses a standard 80° – 82° counter sink.

* Effective Anchor Length

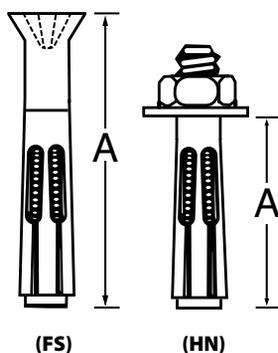

PERFORMANCE TABLE

Dynabolt Sleeve Anchors

Ultimate Tension and Shear Values in Concrete (Lbs/kN)*

ANCHOR DIA. In. (mm)	INSTALLATION TORQUE Ft. Lbs. (Nm)	BOLT DIA. In. (mm)	MINIMUM EMBEDMENT DEPTH In. (mm)	ANCHOR TYPE (STEEL)	f _c = 2000 PSI (13.8 MPa)		f _c = 3000 PSI (20.7 MPa)		f _c = 4000 PSI (27.6 MPa)	
					TENSION Lbs. (kN)	SHEAR Lbs. (kN)	TENSION Lbs. (kN)	SHEAR Lbs. (kN)	TENSION Lbs. (kN)	SHEAR Lbs. (kN)
5/16 (7.9)	8 (10.8)	1/4 (6.4)	1-1/4 (31.8)	Carbon	1,400 (6.2)	2,040 (9.1)	1,920 (8.5)	2,220 (9.9)	2,600 (11.6)	2,400 (10.7)
3/8 (9.5)	14 (19.0)	5/16 (7.9)	1-1/2 (38.1)		1,620 (7.2)	2,560 (11.4)	2,240 (10.0)	2,800 (12.5)	3,100 (13.8)	3,040 (13.5)
1/2 (12.7)	20 (27.1)	3/8 (9.5)	1-7/8 (47.6)		2,220 (9.9)	4,000 (17.8)	3,140 (14.0)	4,500 (20.0)	4,400 (19.6)	5,000 (22.2)
5/8 (15.9)	48 (65.1)	1/2 (12.7)	2 (50.8)		3,080 (13.7)	6,440 (28.6)	4,400 (19.6)	7,240 (32.2)	6,120 (27.2)	8,080 (35.9)
3/4 (19.1)	90 (122.0)	5/8 (15.9)	2-1/4 (57.2)		4,200 (18.7)	10,200 (45.4)	6,060 (27.0)	11,600 (51.6)	8,900 (39.6)	13,100 (58.3)

* For continuous extreme low temperature applications, use stainless steel.

Dynabolt Sleeve Anchors

Ultimate Tension and Shear Values in Lightweight Concrete (Lbs/kN)*

ANCHOR DIA. In. (mm)	INSTALLATION TORQUE Ft. Lbs. (Nm)	BOLT DIA. In. (mm)	MINIMUM EMBEDMENT DEPTH In. (mm)	ANCHOR TYPE (STEEL)	f _c = 4000 PSI (27.6 MPa)		f _c = 6000 PSI (41.4 MPa)	
					TENSION Lbs. (kN)	SHEAR Lbs. (kN)	TENSION Lbs. (kN)	SHEAR Lbs. (kN)
5/16 (7.9)	8 (10.8)	1/4 (6.4)	1-1/4 (31.8)	Carbon	1,260 (5.6)	1,680 (7.5)	1,440 (6.4)	2,220 (9.9)
3/8 (9.5)	14 (19.0)	5/16 (7.9)	1-1/2 (38.1)		1,620 (7.2)	2,300 (10.2)	2,240 (10.0)	2,800 (12.5)
1/2 (12.7)	25 (33.9)	3/8 (9.5)	1-7/8 (47.6)		2,600 (11.6)	3,920 (17.4)	3,160 (14.1)	4,840 (21.5)
5/8 (15.9)	48 (65.1)	1/2 (12.7)	2 (50.8)		3,240 (14.4)	5,600 (24.9)	4,300 (19.1)	7,840 (34.9)
3/4 (19.1)	90 (122.0)	5/8 (15.9)	2-1/4 (57.2)		3,640 (16.2)	8,640 (38.4)	5,800 (25.8)	12,480 (55.5)

Dynabolt Sleeve Anchors

Ultimate Tension and Shear Values in Masonry Units (Lbs/kN)*

ANCHOR DIA. In. (mm)	INSTALLATION TORQUE Ft. Lbs. (Nm)	BOLT DIA. In. (mm)	MINIMUM EMBEDMENT DEPTH In. (mm)	ANCHOR TYPE (STEEL)	LIGHTWEIGHT				MEDIUM WEIGHT			
					HOLLOW CORE		GROUT FILLED		HOLLOW CORE		GROUT FILLED	
					TENSION Lbs. (kN)	SHEAR Lbs. (kN)	TENSION Lbs. (kN)	SHEAR Lbs. (kN)	TENSION Lbs. (kN)	SHEAR Lbs. (kN)	TENSION Lbs. (kN)	SHEAR Lbs. (kN)
3/8 (9.5)	15 (20.3)	5/16 (7.9)	1-1/2 (38.1)	Carbon	1,360 (6.0)	2,560 (11.4)	1,360 (6.0)	2,560 (11.4)	1,360 (6.0)	2,560 (11.4)	1,360 (6.0)	2,560 (11.4)
1/2 (12.7)	25 (33.9)	3/8 (9.5)	1-7/8 (47.6)	Carbon	---	---	2,220 (9.9)	4,000 (17.8)	---	---	2,220 (9.9)	4,000 (17.8)
5/8 (15.9)	55 (74.6)	1/2 (12.7)	2 (50.8)	Carbon	---	---	3,080 (13.7)	6,440 (28.6)	---	---	3,080 (13.7)	6,440 (28.6)
3/4 (19.1)	90 (122.0)	5/8 (15.9)	2-1/2 (63.5)	Carbon	---	---	4,200 (18.7)	10,200 (45.4)	---	---	4,200 (18.7)	10,200 (45.4)

* Allowable values are based upon a 4 to 1 safety factor. Divide by 4 for allowable load values. The tabulated values are for anchors installed in a minimum of 12 diameters on center and a minimum edge distance of 6 diameters for 100 percent anchor efficiency. Spacing and edge distance may be reduced to 6 diameter spacing and 3 diameter edge distance, provided the values are reduced 50 percent. Linear interpolation may be used for intermediate spacings and edge distances.

Combined Tension and Shear Loading—for Dynabolt Anchors

Allowable loads for anchors subjected to combined shear and tension forces are determined by the following equation: $(P_s/P_t) + (V_s/V_t) \leq 1$

P_s = Applied tension load V_s = Applied shear load P_t = Allowable tension load V_t = Allowable shear load

Hammer-SetTM Anchors

Nail-Drive Anchors



APPLICATIONS



NOT FOR USE IN OVERHEAD APPLICATIONS*

- Electrical boxes
- Conduit clips
- Drywall track
- Roof flashing

DESCRIPTION/SUGGESTED SPECIFICATIONS

Hammer-Set Nail Drive Anchors— SPECIFIED FOR ANCHORAGE INTO CONCRETE, BLOCK AND BRICK



Hammer-Set
Nail-Drive
Anchor

The Hammer-Set one-piece zinc plated steel anchor consists of an expansion body and expander drive pin. Anchors meet or exceed GSA specification A-A-1925A Type 1. (Formerly GSA: FF-S-325 Group V, Type 2, Class 3)

ADVANTAGES

- Fast, easy installation
- Works in concrete, block and brick
- Install through material to be fastened
- Low profile mushroom head style

APPROVALS/LISTINGS

Meets or exceeds GSA specification A-A-1925A Type 1 (Formerly GSA: FF-S-325 Group V, Type 2, Class 3)

INSTALLATION STEPS

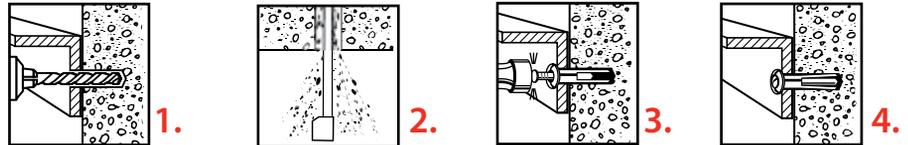

1. Drill proper size hole through material to be fastened into base material. (See Chart for bit size).
2. Clean hole.
3. Insert Hammer-Set into hole until head of anchor body is flush with material to be fastened. Tap the nail until flush with head of anchor. Ensure minimum embedment is 1/4" deeper than anchor embedment. Be sure head is firmly against fixture
4. Anchor is now set. ** NOT RECOMMENDED FOR OVERHEAD **

SELECTION CHART

Hammer-Set

PART NUMBER	DESCRIPTION In. (mm)	DRILL SIZE In. (mm)	MAX. FIXTURE THICKNESS In. (mm)	MIN. EMBEDMENT In. (mm)	MIN. HOLE DEPTH In. (mm)	QTY/WT PER BOX lbs.	QTY/WT PER MASTER CTN-lbs.
HS-1607	3/16 x 7/8 (4.8 x 22.2)	3/16 (4.8)	1/4 (6.4)	5/8 (15.9)	1-1/8 (28.6)	100/ 2.0	1000/ 20
HS-1412	1/4 x 1-1/4 (6.4 x 31.8)	1/4 (6.4)	1/2 (12.7)	3/4 (19.1)	1-1/2 (38.1)	100/ 2.6	1000/ 26
HS-1414	1/4 x 1-1/2 (6.4 x 38.1)	1/4 (6.4)	3/4 (19.1)	3/4 (19.1)	1-3/4 (44.5)	100/ 2.8	1000/ 28
HS-1420	1/4 x 2 (6.4 x 50.8)	1/4 (6.4)	1-1/4 (31.8)	3/4 (19.1)	2-1/4 (57.2)	100/ 3.5	1000/ 35

PERFORMANCE TABLE

Hammer-Set

**Ultimate Tension and Shear
Values in Concrete (Lbs/kN)***

ANCHOR DIA. In. (mm)	EMBEDMENT In. (mm)	4000 PSI (27.6 MPa)	
		TENSION Lbs. (kN)	SHEAR Lbs. (kN)
3/16" (4.8)	5/8" (15.9)	640 (2.8)	810 (3.6)
1/4" (6.4)	3/4" (19.1)	880 (3.9)	970 (4.3)
1/4" (6.4)	1" (25.4)	950 (4.2)	970 (4.3)
1/4" (6.4)	1-1/4" (31.8)	1,025 (4.6)	970 (4.3)

Safe working loads for single installations under static loading conditions should not exceed 25% of the ultimate capacity.

FREE SOFTWARE

Canadian Design Standard – CSA A23.3-14

AVAILABLE IN ENGLISH AND FRENCH CANDIAN

truspec[>]
ANCHOR CALCULATION SOFTWARE 3.0



The most user-friendly anchor design software is now even better, allowing you to do more types of anchor designs from anywhere, be that in the office or out on the jobsite.

NEW! Access cloud-based Truspec v3 via web browser from your computer or mobile device.

- Cloud-based version means users always have access to the latest features, without the hassle of installing updates.
- Can access from 4G mobile devices even without wi-fi internet connection.

Versatile – do everything in one package

- **NEW** Supports cast-in as well as post-installed anchor design
- **NEW** Supports anchoring to masonry (available Q1 2020) as well as concrete substrates
- **NEW** Allows you to customize base plate shapes and anchor layouts



Customize base plate shapes and anchor layouts

Accurate, reliable, Canadian code-compliant anchor designs (CSA A23.3-14)

- **NEW** Supports ACI318 Strength Design method for concrete and Allowable Stress Design (ASD) for masonry.
- **NEW** Truspec v3 lets you enter multiple load combinations and calculates the worst-case controlling combination for you.
- **NEW** Truspec v3 checks your base plate design using finite element analysis to ensure adequate rigidity



Intuitive, easy to use

- Consistently ranked by designers as one of the simplest anchor design software to learn and use, Truspec v3 walks you through the anchor design and selection process in six easy steps – saving time and preventing errors.
- Customizable templates are provided for common anchoring applications like base plates, end plates and safety railings.
- Graphical user interface provides 2D and 3D design views making it easy to visualize all design elements at a glance.
- Tooltip messages provide helpful information whenever the cursor is positioned over an element on the user interface.
- Animated indicators simplify and speed the input of tensile, shear and moment load values
- Truspec allows you to filter anchor recommendations by type, diameter, steel grade, etc. Truspec also ranks the viable options to show which are the most efficient from a capacity utilization perspective.

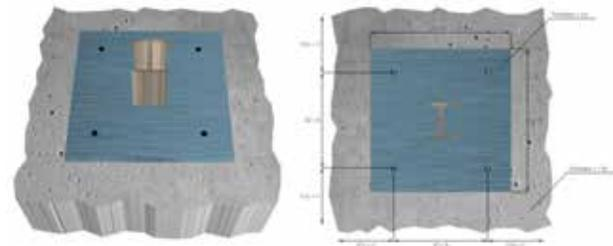

View anchor designs in 2D or 3D perspective

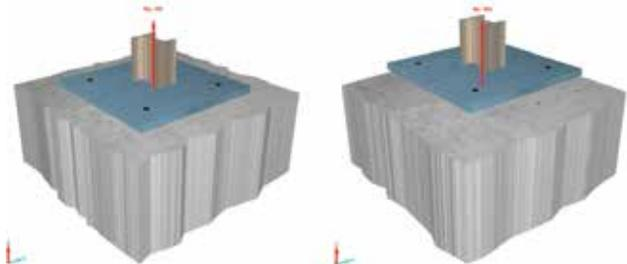

Animated display graphically shows load direction

The NEW, enhanced design report shows all inputs, formulas, and calculations with relevant standards citations, plus complete anchor product info and installation instructions.

USE TRUSPEC V3 SOFTWARE WITH THE FOLLOWING POPULAR ANCHORING PRODUCTS:

CHEMICAL ANCHORING ADHESIVES

- **Red Head A7+ Adhesive**
The most versatile quick cure
Fast-curing, all-weather hybrid adhesive

POST-INSTALLED MECHANICAL ANCHORS

- **Trubolt Wedge Anchors**
Dependable, heavy-duty expansion anchor
- **Tapcon and Tapcon+ Screw Anchors**
Fast installation with reliable holding power
- **Sammys Threaded Rod Hangers**
Accommodates vertical, horizontal and angled attachments

CAST-IN ANCHORS

- **Hex and heavy hex head bolts**
- **Square and heavy square head bolts**

Notes



National Headquarters

120 Travail Road
Markham, Ontario, L3S 3J1

Tel: 905-471-7403
800-387-9692

Fax: 905-471-7208
800-668-8688

Technical and Customer Service Support

Tel: 800-387-9692

Fax: 800-668-8688

Regional Warehouses

- Markham, Ontario
- Coquitlam, British Columbia
- Calgary, Alberta

Take Advantage of these Contractor Services from ITW Construction Products Canada

From job sites to engineering firms, from Safety Seminars to on-site services, we hope you take advantage of our many contractor services— at no charge! After all, it's one thing to offer the quality products you need to do your job. It's another to provide you with superior service, engineering expertise and total product support.

At ITW Construction Products Canada, we are proud of the partnerships we have built through the years with our distributor network and contractors. Thanks to quality products, innovative services and on-time delivery, we will continue to build new relationships and strengthen existing ones today... and into the next century.

- Factory representatives with years of training and service experience will go out to your job site to provide you with product, service and technical assistance.
- We provide architects and engineers with complete submittal packages which gives them the technical data needed to specify ITW Construction Products Canada products. Contact your ITW Construction Products Canada Distributor or your nearest Customer Service location to request submittal packages.

Technical Application Assistance:

- Our staff of application specialists are ready to assist you with any type of application or code approval question during any phase of your project. Call 1-800-387-9692 between 8:00 a.m. and 5:00 p.m. EST, Monday through Friday.

Distributed By

Ramset, T4, T3, T3Cup, Trakfast, GypFast, Mastershot, Triggershot, Hammershot, PowerPoint, TE Pin and Climacoat are trademarks of Illinois Tool Works, Inc.

A7+, Dynabolt, Hammer-Set, LDT, Multi-Set II, Poly Set, Red Head, Redi-Drive, S7, Striker, and Trubolt are trademarks of ITW Red Head and Illinois Tool Works, Inc.

Teks, TruGrip GT, Scots, Maxiseal, Dek-Cap, Tapcon, SG, Tapcon, Maxi-Set Tapcon, Condrive, E-Z Anchor, Twist-N-Lock, E-Z Lite, E-Z Mini, Stud Solver, Hi-Lo, S-T2, Backer-On, Rock-On, DeckKing, Dec-U-Drive, Dek-Cap, Grid-Mate, Grid-Mate, PB, Climaseal, Spex, Climacoat, UltraShield, Climashield and Building Ideas That Work are trademarks of ITW Buildex and Illinois Tool Works, Inc.

Sammys, Sammy X-Press, Sammy X-Press It, Sammy X-Press Swivel, Sammy X-Press Sidewinder, Tapcon, Sammy Saddle, Speedy Pole Tool, Spot-Rite Level, and Truss-T Hanger are trademarks of ITW Buildex and Illinois Tool Works, Inc.

The term "Paslode" is a trademark and the Paslode logo and all related product and service names, designs and slogans are Paslode trademarks. Paslode, RoundDrive, Impulse, Positive Placement are registered trademarks, PowerFramer and quicklode are trademarks of Illinois Tool Works.

R4, RSS, Kameleon, Fin/Trim, RT Composite, Low Profile Cabinet, Pheinox, Top Star, VWS, Caliburn, and The GRK Fasteners Canada Ltd. and all associated designs and logos are trademarks of GRK Fasteners Canada Ltd., used under license.

Hilti is a registered trademark of Hilti, Corp.

DensGlass is a registered trademark of Georgia Pacific Building Products.

Dekstrip, Dektite, Retrofit Dektite, and Dektite are registered trademarks of Deks Industries Pty Ltd.

Phillips Square-driv is a registered trademark of the Phillips Screw Company.

The information and recommendations in this document are based on the best information available to us at the time of preparation. We make no other warranty, expressed or implied, as to its correctness or completeness, or as to the results or reliance of this document.